

The Intel 80x86 processor family supports a wide variation of machine instructions. You can perform many operations with several different instruction sequences. While this variety makes it easier to develop an algorithm in assembly language, it complicates determining the *optimal* sequence of instructions necessary for the job. In this laboratory you will study the operation of many instructions in the 80x86 instruction set and compare instruction timings for sequences which perform the same operation.

## 6.1 The 80x86 Flags Register

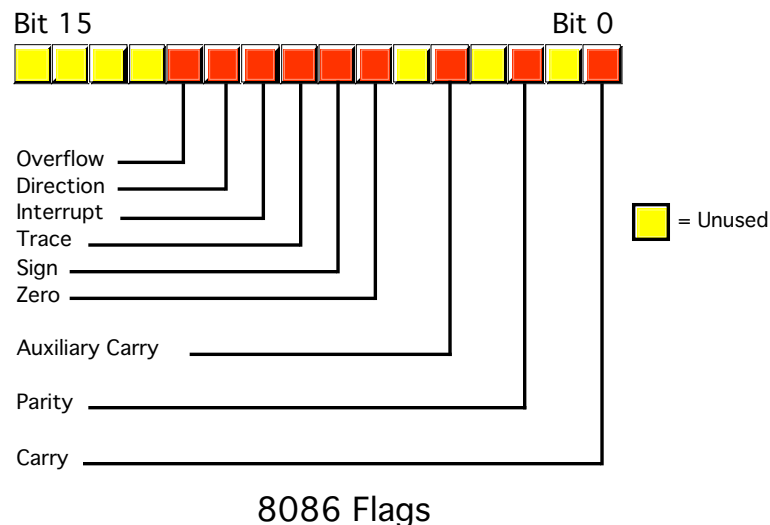

The 80x86 microprocessors use several bits in the flags register to control the operation of the CPU and denote the current machine state. The *condition code bits* (overflow, sign, zero, carry, and parity) let you test the results of completed computations. The machine state bits (direction, interrupt, and trace) let you control the operation of the machine. Finally the auxiliary carry flag holds important status information for BCD operations.

The 80x86 provides special instructions which let you test the settings of the five condition code bits. These instructions include the conditional jump (Jcc) instructions and the conditional set instructions (SETcc, available only on 80386 and later processors). Indeed, the whole reason these five flags have the name “condition codes” is because you can execute instructions which conditionally test them.

### 6.1 Which flags are the condition codes?

The machine state flags control the operation of the CPU. These flags include the direction flag, the trace flag, and the interrupt disable flag. The trace flag gives debuggers such as CodeView the ability to *single-step* through a section of code. Application programs rarely change this flag. The direction flag controls the operation of the string instructions. The interrupt disable flag controls whether hardware *interrupts* are active. Usually, interrupts are always on. An application can turn off interrupts for brief periods of time when executing certain critical code.

The auxiliary carry flag, set by certain arithmetic operations, denotes a carry while performing BCD arithmetic. You cannot directly set or clear it, nor can you directly test it. Since the text does not consider BCD arithmetic, we will ignore this flag.

The 80x86 provides several instructions which directly affect the flags. These include CLC (clear carry), STC (set carry), CMC (complement carry), CLD (clear direction), STD (set direction), CLI (clear interrupt), STI (set interrupt), POPF/POPF (pop flags), and SAHF (store AH into flags).

Although the 80x86 does not provide specific instructions to set and clear other flags, you can use the LAHF/SAHF and PUSHF/POPF instructions to accomplish this. For example, to set the parity flag use an instruction sequence like

```
lahf
or    ah, 100b           ;Parity is bit #2 in the flags register.
sahf
```

Keep in mind that the SAHF instruction does not affect the overflow flag and the OR instruction clears the overflow flag. If you need to preserve or modify the overflow, interrupt, or trace flag in the above sequence, you will need to use code like the following:

```
pushf
pop   ax
or    ax, flag_bits     ;Use AND to clear bits.
push  ax
popf
```

## 6.2 Which flags do the SAHF and LAHF instructions deal with?

---

## 6.3 The SAHF/LAHF instructions will not let you modify which condition code?

---



---

## 6.2 Data Movement Instructions

Important data movement instructions include mov, xchg, lea, lds, les, lfs, lgs, lss, push, pop, pusha, popa, pushf, popf, lahf, and sahf. Keep in mind, *most* instructions move data around (often manipulating it at the same time). These instructions fall into this category because data movement is their primary goal<sup>1</sup>.

---

### 6.2.1 MOV dest, source

The mov instruction copies data from a source operand to a destination operand. Chapter Four covers this instruction in detail, there is no need to consider it here.

The xchg instruction swaps the data between its operands. One operand must be a register, the other may be a register or a memory location. There is a special (one byte) version of this instruction that swaps AX with another register. The nop instruction is really a synonym for xchg ax, ax.

### 6.4 Suppose you want to exchange the values in the AX and BX registers. Using only MOV instructions and the AX, BX, and CX registers, write the code to do this:

---



---



---

### 6.5 Suppose you want to swap the 16-bit values in memory locations I & J. What three instructions will do this job (hint: only one is an XCHG):

---



---



---



---

1. ENTER and LEAVE are exceptions to this rule. We'll consider them here because they mesh so well with the PUSH/POP instructions.

## 6.2.2 LEA reg, memory

The `lea` (Load Effective Address) instruction computes the address of its memory operand and stores this address in the 16-bit register operand. This instruction also computes an effective address in addition to moving data around, so it is really an arithmetic statement, but most texts classify it as a data movement instruction.

The `lea` instruction is useful for setting up a pointer to some data structure in memory. For example, if you have a pointer to an array in `bx` and an index into that array in `si`, you can generate a pointer to the 3<sup>rd</sup> byte of that array element using the instruction `lea bx, [bx+si+3]`. From that point forward you can access the specified element by using the `[bx]` addressing mode. On many members of the 80x86 family, the simpler addressing mode is also faster (and it's always shorter). This is particularly useful if you can set up a register outside a loop and use a faster addressing mode inside the loop:

```

ThisLoop:    lea    bx, [bx+si+3]
             mov    [bx], al
             loop  ThisLoop

```

### 6.6 What will the “LEA AX, lbl[bx]” instruction do?

---



---

### 6.7 What is the difference between “LEA ax, [bx]” and “MOV ax, [bx]”?

---



---

### 6.8 Why isn't “LEA ax, bx” legal? Explain

---



---

The `lds`, `les`, `lfs`, `lgs`, and `lss` instructions let you load a 32-bit value into one of the 80x86's segment registers and a 16-bit general purpose register. The primary use of this instruction is to load a far pointer into a segment register and a pointer register. Although the instruction manipulates 32-bit quantities (even on eight and sixteen bit processors), you should not use this instruction for purposes other than initializing a segment/base register pair. Keep in mind that `lfs`, `lgs`, and `lss` are available only on 80386 and later processors.

As an example, consider the UCR Standard Library `puts` routine (see Chapter Six). This routine requires a pointer to a *zero terminated string*<sup>2</sup> in the `es:di` register pair. The following code will do this job:

```

String      byte   "string to print",0
StrPtr      dword  String
            .
            .
            .
            les   di, StrPtr
            PUTS

```

---

2. A sequence of ASCII characters ending with a byte containing zero.

Note that the `les` instruction above *does not* copy the address of `StrPtr` into `es:di`. Instead, it loads `es:di` with the 32 bits found at the source operand. The instruction `LES di, String` generates an error (see Chapter Six). Even if it would work, it would not load the address of `String` into `es:di`, it will load the four bytes “`stri`” into `es:di`.

**6.9 What LxS instructions are available on all 80x86 processors?**

---

**6.10 What will the LES DI, [BX+3] instruction do?**

---

**6.2.3 PUSH and POP**

The push and pop instructions are the most complex in the data movement group. These instructions move data between registers/memory and the 80x86 *stack*. The stack is a region in memory contained within the *stack segment*, referenced by the 80x86 *stack pointer* register. The 80x86 CPUs automatically use the stack to store temporary data. You can also use the stack for temporary data using the push and pop instructions.

The 80x86 stack is a *last in first out* (LIFO) data structure. That is, the last thing you store onto the stack will be the first thing you retrieve from the stack. This type of data structure is particularly useful for various operations, particularly the subroutine call/return mechanism. The classic example of a stack is a dishwell at a local restaurant. The first plates the bus boy places into the dishwell are the *last* plates removed. Likewise, the last plates placed in the dishwell will be the first plates removed:

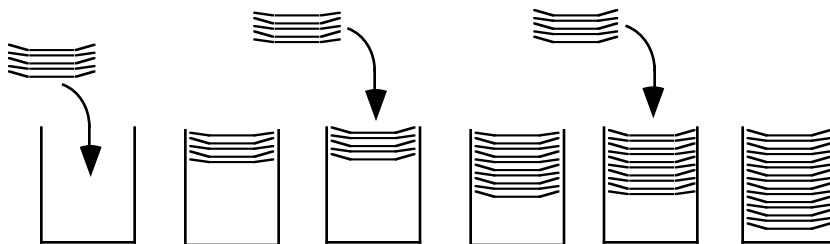

Pushing Plates onto the Stack

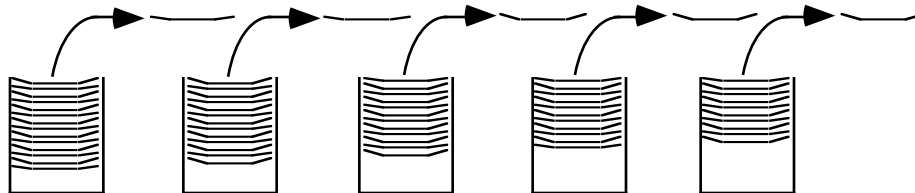

Popping Plates from the Stack

As you can see in the diagram above, the very first plate placed on the stack winds up on the bottom. It will be the very last plate removed from the dishwell. The 80x86 stack works in a similar fashion. The first values you push onto the stack are the last values you pop off the stack; the last values you push onto the stack are the first popped from the stack.

**6.11 What does “LIFO” stand for?**

---

**6.12 If you were to push AX and BX on the stack (in that order), which value would you pop off the stack first?**

---

The push instructions operate on 16-bit (push) or 32-bit (pushd) operands. You cannot push eight-bit values onto the 80x86 stack. The PUSH instructions subtract two from SP and then store the operand's value at memory location ss:sp. The pushd instructions (available only on 80386 and later processors) subtract four from sp and then store their operand at location ss:sp. Note that ss:sp always points at the last item pushed on the stack.

The pop and popd instructions operate in a similar fashion, undoing the push/pushd. They copy the value from memory location ss:sp to their destination operand, then add two or four to sp (two for pop, four for popd). Note that the 80x86 stack grows *down* in memory. That is, as you push things onto the stack, the stack uses lower and lower memory locations.

**6.13 If SP contains 8010h and you push AX onto the stack, what will SP contain after the push?**

---

**6.14 If SP contains 7FFCh and you push EAX onto the stack, what will SP contain after the PUSHHD?**

---

**6.15 If you pop the value on the stack into BX when SP contains 801Ch, what will SP contain after the pop?**

---

The push/pushd instructions allow several different types of operands. You may push any of the 80x86's general purpose 16/32-bit registers, 16-bit segment registers, 16/32-bit memory locations, or 16/32-bit constants<sup>3</sup>. Except for constants, pop and popd support this same operand set.

The pushf and pushfd instructions push the flags register. The popf and popfd instructions pop the flags register. These instructions do not require any operands.

The 80286 and later processors also support "push all" and "pop all" instructions (pusha/pushad and popa/popad). These instructions push the set of general purpose registers onto the stack or pop them off the stack.

**6.16 The 80x86 CPUs do not let you load immediate constants into a segment register. Describe how you could use a push and pop instruction on the 80286 and later processors to load a constant into DS:**

---



---

**6.17 If you push AX then BX onto the stack, and then pop AX and BX off the stack (in that order), you will exchange the values in AX and BX. Explain:**

---

5.2 Carry, Aux Carry, Parity, Zero, and Sign.

5.3 Overflow

5.4 MOV CX, AX  
MOV AX, BX  
MOV BX, CX

5.5 MOV AX, I  
XCHG AX, J  
MOV I, AX

5.6 Loads the offset of "LbI" plus the current value of BX into AX.

5.7 LEA AX, [BX] simply copies the value of BX into AX. MOV AX, [BX] loads the memory location pointed at by BX into AX

5.8 The second operand of LEA must be a memory addressing mode.

3. Pushing constants only works on 80286 and later processors, pushing 32-bit values only works on 80386 and later processors.

---



---

The PUSH and POP instructions are especially useful for temporarily saving the value in a register so you can use that register for some other purpose. For example, suppose you want to add word variables I and J together, storing the result into K, but all your general purpose registers contain important values. You could use the following code to resolve this dilemma:

```

push  ax
mov   ax, i
add   ax, j
mov   k, ax
pop   ax

```

There are a couple of very important rules you must always observe when using the stack to store temporary values. (1) You must always pop values off the stack in the *reverse* order that you push them onto the stack (see question 5.17 above). (2) If you push a value onto the stack, you must pop it off the stack. (3) Likewise, you shouldn't be popping values off the stack that you haven't pushed onto the stack.

A very common mistake in assembly language programs is to pop items from the stack in the same order they were pushed. Remember, the stack is a *last in first out* data structure. If you execute the instruction sequence:

```

push  ax
push  bx
push  cx
push  dx

```

followed by

```

pop   ax
pop   bx
pop   cx
pop   dx

```

the first pop instruction (pop ax) pops the *last* value pushed on the stack. This happens to be the value in DX at the time of the push sequence. Note that the sequence above effectively executes the instructions:

```

xchg  ax, dx
xchg  bx, cx

```

The push instructions always push the H.O. byte of their operand first. This guarantees that the pushed item appears in memory with its L.O. byte at the lowest address (remember, the stack grows downward in memory). To match this, the pop instructions always pop the L.O. bytes first and the H.O. bytes last.

**6.18 If you push EAX on the stack and then pop BX followed by AX, describe the values in the BX and AX registers after this sequence:**

---



---



---

## 6.2.4 LAHF and SAHF

The lahf and sahf instructions copy the L.O. eight bits of the flags register into AH (lahf) or store AH into the L.O. eight bits of the flags register (sahf). Intel originally included these instructions in the instruction set for compatibility with their older 8080/8085 microprocessors. Today, no one cares about such compatibility so these instructions do not see much use. Their primary use is with the floating point instruction set on the 80x87 (see the chapter on floating point arithmetic) and as a means of directly manipulating many of the flags. One major drawback to these instructions is that the 80x86 overflow flag does not appear in the L.O. eight bits of the flags register.

## 6.3 Sign/Zero Extension and Conversion Instructions

The 80x86 family provides several instructions for performing various data conversions: bswap, cbw, cwd, cwde, cdq, movsx, movzx, and xlat.

### 6.3.1 BSWAP

Bswap (available only on 80486 and later processors) swaps bytes zero and three and bytes one and two in the destination register operand. This operation is useful for converting between 32-bit big and little endian values.

**6.19 The BSWAP instruction only swaps the bytes in a 32-bit register. What 80x86 instruction can you use to swap the two halves of the AX register?**

Suppose that you've obtained a binary image of an array of 32-bit integers created on a Motorola 68040 microprocessor (which uses big endian byte ordering). The following sequence of 80486 instructions will convert this array to the little endian data format the 80x86 processors use:

```

                                mov     cx, ArraySize      ;Number of elements .
                                lea    bx, Array          ;Ptr to 1st element.
Big2Little:                    mov     eax, [bx]          ;Get next element.
                                bswap  eax                ;Make little endian.
                                mov    [bx], eax          ;Save result away.
                                add    bx, 4              ;Move ptr to next guy.
                                loop   Bit2Little

```

### 6.3.2 CBW, CWD, CWDE, CDQ, MOVSX, and MOVZX

The cbw (convert byte to word) and cwd (convert word to double) instructions are available on all 80x86 processors. They sign extend al into ax (cbw) and ax into dx:ax (cwd). cwde also sign extends the 16-bit value in ax to 32 bits, but it leaves its result in eax rather than dx:ax. The Cdq instruction sign extends the 32-bit value in eax to a 64-bit value in edx:eax. The major drawback to these instructions is that they only operate on the accumulator. Furthermore, they leave their result in the accumulator and (possibly) the dx register. The movsx instruction eliminates these two restrictions by letting you move and sign extend any operands acceptable to the mov instruction. The only difference is that the destination operand must be larger than the source operand. The movzx instructions works in a similar fashion, but it zero extends rather than sign extends its operand.

**6.20 What is an easy way to zero extend AL into AX using only a MOV instruction?**

**6.21 Given the solution to question 5.20, can you come up with an example which demonstrates why one would want to use the MOVZX instruction?**

5.9 LDS and LES

5.10 Load DI from location BX + 3 and load ES from location BX + 5.

5.11 Last in first out

5.12 BX.

5.13 800Eh.

5.14 7FF8h.

5.15 801Eh.

5.16 PUSH constant  
POP DS

5.17 Since you pushed AX then BX, BX's value is the first popped off the stack. Hence if you execute POP AX followed by POP BX you will pop BX's old value into AX and AX's old value into BX.

Although these instructions are generally applicable anytime you want to extend the size of a signed integer value, it is especially crucial that you remember to zero or sign extend the accumulator operand when using the `div` and `idiv` instructions. Keep in mind that `div` and `idiv` divide the 16/32/64-bit values in `ax`, `dx:ax`, or `edx:eax` by an 8/16/32-bit operand. If you really want to perform an 8/8, 16/16, or 32/32 bit division, you can use the zero and sign extension instructions to extend the dividend to the appropriate size before the division takes place.

**6.22** Suppose you want to divide the (signed) value in `AX` by the value in `BX` using the `IDIV` instruction. `IDIV` requires a 32-bit value in `DX:AX` prior to the division. Which instruction would you use to do this?

The following code sequence computes the average of the elements in an array. The array contains 16-bit signed integers and the number of elements in the array is given by the 16 bit variable *ArraySize*:

```

                mov     cx, ArraySize      ;# of items to ave.
                lea    bx, Array          ;Get ptr to array.
                mov    ax, 0              ;Init sum.
AveLoop:       add    ax, [bx]           ;Add in next element.
                add    bx, 2              ;Point at next item.
                loop   AveLoop

; AX now contains the sum of all items in the array.
; Compute the average by dividing by ArraySize.

                cwd                      ;Sign extend to dx:ax
                idiv   ArraySize

; Average is now in AX.
```

This code makes two important assumptions: `ArraySize` cannot be zero and the sum of all the array elements must fit into 16 bits.

### 6.3.3 XLAT

The `xlat` instruction performs a very simple, yet powerful, operation. It loads `al` with the value found in memory location `ds:[bx+al]`. Now this might seem like a somewhat esoteric operation, but it turns out to be quite useful. As its name implies, the `xlat` (translate) instruction lets you translate values from one form to another. For example, suppose you want to convert the L.O. nibble of `AL` into the hexadecimal character which represents that value (i.e., you want to convert 0..F to '0..'F'). The following short section of code will do this:

```

HexTable       byte   "0123456789ABCDEF"
                .
                .
                .
                and    al, 0Fh          ;Strip H.O. nibble
                lea    bx, HexTable     ;Load BX with HexTable's base address.
                xlat
```

This code assumes that the `DS` register points at the segment containing the `HexTable` array.

**6.23** Suppose you have a table of 256 bytes which contain the values 0, 1, 2, 3, ... 0FFh. If `BX` points at the first byte of this table, what value will `AL` contain after the execution of the `XLAT` instruction? Explain

---



---



---



**6.24** Suppose you have a table like the one above, except that it contains 'a' through 'z' at indices 41h through 5Ah (ASCII codes for 'A'..'Z'). Explain what the XLAT instruction will do when used with this table.

---



---



---



---



---

5.18 BX will contain the original value in AX and AX will contain the original H.O. word of EAX.

**6.25** Suppose you want to create a function which returns a one in AL if the character in AL is a punctuation character, a zero otherwise. Describe the table you would need to implement this function with the XLAT instruction:

---



---



---



---



---

5.19 XCHG AL, AH

**6.26** Suppose SI contains the input value for the function in problem 5.25 above. What instruction could you use to perform the same operation as the XLAT above?

---



---



---



---

5.20 MOV AH, 0

**6.27** What could happen if you do not have exactly 256 bytes in the table pointed at by BX?

---



---



---



---



---

5.21 MOVZX BX, AL or any other instruction whose destination is not an eight bit register or AX.

## 6.4 Arithmetic Instructions

The 80x86 arithmetic instructions include add, adc, cmp, dec, div, idiv, imul, inc, mul, neg, sub, and sbb. The are others, see the textbook for additional information.

The basic syntax these instructions is

```
add    dest, src
adc    dest, src
cmp    dest, src
```

```

dec    dest
div    src
idiv   src
imul   src
imul   dest, src, immediate
imul   dest, immediate
imul   dest, src
inc    dest
mul    src
neg    dest
sub    dest, src
sbb    dest, src

```

Only the first version of the IMUL instruction above is available on all versions of the 80x86 family. The remaining versions require an 80286 or later processor (see the textbook). The other instructions are all available on every member of the 80x86 family.

### 6.4.1 ADD, ADC, SUB, SBB, and CMP

The add/adc, sub/sbb, and cmp instructions work for both signed and unsigned operands. Given the nature of the two's complement system, they perform *both* operations simultaneously. The syntax for these instruction is

```

add    dest, source
adc    dest, source
sub    dest, source
sbb    dest, source
cmp    dest, source

```

The add instruction computes  $dest := dest + source$  and sets the condition code flags depending on the result. Likewise, the sub instruction compute  $dest := dest - source$  and sets the flags accordingly. The adc and sbb instructions work just like the add and sub instructions except they add in or subtract out the value of the carry flag (zero or one) in addition to the source operand. This lets you take the overflow from one computation and add it into another.

**6.28** If the carry flag is set, what will the instruction “ADC AX, BX” do?

**6.29** What will the above instruction do if the carry flag is clear?

Since the SHL instruction copies the H.O. bit of its operand into the carry flag and the ADC instruction can add the current value of the carry flag into an operand, it is very easy to construct a short loop which will count the number of one bits in an operand. Consider the following loop that provides one way to count the number of set bits in the bx register:

```

CountBits:  mov    cx, 16           ;Do 16 bits.
            mov    ax, 0           ;Initialize sum to zero.
            shl    bx, 1           ;SHR would work, too.
            adc    ax, 0           ;Add this bit to the sum.
            loop  CountBits

```

The cmp instruction works like the SUB instruction except it does not store the difference into the destination operand. Instead, it simply updates the 80x86's flags register. You can use the conditional set and jump instructions after a cmp instruction to test the result of the comparison.

**6.30** The CMP is a *non-destructive* operation because it does not modify the value of either operand. Give an example of an instruction which performs the same operation as CMP but is a *destructive* operation:

The `cmp` instruction will set the carry flag if the first (unsigned) operand is less than the second; that is, the `jb` and `jc` instructions are one and the same. The following example takes advantage of this fact. It determines whether a given value is greater than or less than the median in an array of values. It does this by counting the number of entries in the array which are smaller than the value in `dx`, multiplies this result by two, and then compares this to the number of elements in the array:

```

        lea    bx, Array           ;Init ptr to data.
        mov    cx, ArraySize      ;# of items.
        mov    dx, TestValue      ;Check this value.
        mov    ax, 0              ;Init sum.
MedianSum:  cmp    dx, [bx]        ;C=1 if less than.
        adc    ax, 0              ;Bump less than cntr.
        add    bx, 2              ;On to next element.
        loop  MedianSum

; AX now contains the number of array elements which
; were less than the value of TestValue. If this value,
; multiplied by two, is greater than the number of
; elements in the array then TestValue is greater than
; the median value. Otherwise it is less than or
; equal to the median value.

        shl   ax, 1              ;Multiply by two.
        cmp   ax, ArraySize      ;See if > median
        ja    AboveMedian       ;Go elsewhere if >.

; If the code falls through to this point, then TestValue
; is less than or equal to the median value.

```

---

## 6.4.2 INC and DEC

The `inc` and `dec` instructions add one or subtract one from their single operand. They behave just like the `add dest,1` and `sub dest,1` except that these instructions do not affect the carry flag.

**6.31 Besides the fact that the INC and DEC instructions do not affect the carry flag what is a good reason to use these instructions rather than ADD or SUB?**

---



---



---



---

## 6.4.3 NEG

The `neg` instruction takes the two's complement of its operand, thereby negating it. Note that this is the same thing as subtracting the destination operand from zero or (following the standard definition of two's complement) inverting all the bits and adding one. The `neg` instructions sets the flags in a manner identical to the `sub` instruction assuming the destination operand was zero before the subtraction. Hence, the flags will be set as though you had compared zero to the `neg` operand.

5.22 CWD

5.23 It will not affect AL at all since you will be loading AL with the value already present in AL.

5.24 It will convert upper case characters to lower case since if AL contains 'A' through 'Z' prior to XLAT it will load 'a' through 'z' from the corresponding locations in the table. All other values are unchanged.

5.25 Put a zero into each entry of the table whose index is *not* the ASCII code of a punctuation character. Put a one in the entries corresponding to punctuation chars.5.26  
MOV AL, [BX+SI]

5.27 If the value in AL is greater than the maximum number of bytes in the table the XLAT instruction will fetch a byte from beyond the table.

### 6.32 Under what circumstance(s) will the NEG instruction set the zero flag?

---

Although the 80x86 does not have an instruction that computes the absolute value of an integer operand, building one using the neg instruction is very easy. The following two code segments demonstrate how to take the absolute value of the ax register:

```
; Straight-forward example: If AX is negative, negate
; it. This method works best if the number is usually
; negative since the code will not have to branch as
; often.
```

```
        cmp     ax, 0
        jns     NotNeg
        neg     ax
```

NotNeg:

```
; Second example. This one works best if the number is
; usually positive:
```

```
        neg     ax
        jns     NotPos
        neg     ax
```

NotPos:

---

#### 6.4.4 MUL, IMUL, DIV, and IDIV

The multiplication and division instructions come in two basic flavors: mul/div and imul/idiv. These instructions handle unsigned operations (mul/div) and signed operations (imul/idiv). Although the two's complement system performs signed and unsigned addition/subtraction in an identical manner, signed and unsigned multiplication and division are different operations requiring different instructions.

The mul instruction allows only a single memory or general purpose register operand. It is an extended precision unsigned multiply operation that multiplies its operand with the accumulator (al/ax/eax) and produces a result that is twice the size of the accumulator (the result goes into ax, dx:ax, or edx:eax, depending on the operand size). The mul instruction sets the carry and overflow flags if the result does not fit in the same number of bits as the source operand. Note, however, that the result is still correct since mul produces a result twice as large as the source operand<sup>4</sup>.

The imul instruction performs signed arithmetic. This instruction takes several forms:

- IMUL operand                                 ;extended acc := acc \* operand
- IMUL reg, mem/reg, constant               ;reg = mem/reg \* constant
- IMUL reg, constant                         ;reg = reg \* constant
- IMUL reg, reg/mem                         ;reg = reg \* mem/reg

The single operand imul instruction works just like the mul instruction except it works with signed values. The remaining of imul instructions (those with two or three operands) compute a result that is the same size as the source operands. Since the multiplication result may not fit in the destination operand, the result may not be exact. In the event of overflow, imul sets the carry and overflow flags and throws away the high order bits of the result.

### 6.33 What will “IMUL AX, BX, 10” compute?

---



---

4. The product of two n-bit numbers will always fit in no more than 2\*n bits.

The versions of the `imul` instruction that allow immediate operands are especially useful for computing offsets into a multi-dimensional array. For example, consider the following Pascal array:

```
UseMul:array [0..5,0..74] of char;
```

To store a zero into “UseMul[i,j]” you could use the 80286 code:

```
imul  bx, i, 75
add   bx, j
mov   UseMul[bx], 0
```

This version of the `imul` instruction is available only on 80286 and later processors, but it is very convenient if you are using one of these processors.

**6.34 Suppose you have the array “ThreeD:array [0..4, 0..5, 0..6] of char;” What instructions could you use to load element “ThreeD[i,j,k]” into AL**

The following short code segment produces the *cross product* of two arrays. The cross product is the sum of the products of corresponding array elements, e.g.,

```
sum := 0;
for i := 0 to ArraySize do
  sum := sum + A[i] * B[i];
```

The assembly language code that computes this is

```
mov     cx, ArraySize      ;# of elements.
mov     bx, 0              ;Init array index.
mov     bp, 0              ;Hold result here.
CrossLp: mov     ax, A[bx]    ;Get A[i].
imul    B[bx]              ;Multiply by B[i].
add     bp, ax             ;Sum up products.
add     bx, 2              ;On to next element.
loop    CrossLp
```

; BP now contains the cross product.

Note that this code ignores the possibility of overflow. There are actually two places where overflow can occur. First, the `imul` instruction may produce a value in `dx` which is not 0 or 0FFFFh. Second, the `add bp, ax` instruction could overflow and this code does not check for that.

The `div` and `idiv` instructions require a single operand, like the extended precision versions of `mul` and `imul`. There are no special 80286/386 versions of these instructions like `imul`. `Div` is for unsigned operations, `idiv` is for signed operations. These instructions compute the quotient and remainder at the same time. They divide a 64-bit value by a 32-bit value, a 32-bit value by a 16-bit value, or a 16-bit value by an eight-bit value. The operand is the smaller value, the implied operand is either `edx:eax`, `dx:ax`, or `ax`. These instructions place the quotient in the lower half of the implied operand and the remainder in the upper half of the implied operand. *If the quotient does not fit into `eax`, `ax`, or `al` (as appropriate), the `div/idiv` instructions generate a divide error.*

**6.35 Suppose you have the value 2000h in DX:AX and you divide this by the value in BX. What three values in BX will cause the divide instruction to generate a divide error?**

5.28 Compute  $AX := AX + BX + 1$

5.29 Compute  $AX := AX + BX + 0$

5.30 SUB.

5.31 They are shorter and generally faster than the ADD equivalent.

### 6.36 Besides not being able to fit the quotient in the destination register, what other error can the divide instruction encounter?

Since division by zero will immediately bomb your program, you should always check your divisor when using the `div` and `idiv` instructions if you are not absolutely sure they are non-zero. The following code demonstrates how to check for this when computing  $K := I \text{ div } J$ :

```

cmp     J, 0           ;Divisor zero?
je     DivideBy0      ;Error handler code.
mov     ax, I
mov     dx, 0         ;Remember to zero extend!
div     J
mov     K, ax

```

Handling the second major problem with division, producing a quotient which will not fit into the destination register, is a little more difficult. The solution most people adopt is to perform an n-bit by n-bit division rather than a 2n-bit by n-bit division. The example above demonstrates this. I, J, and K are all 16-bit variables. This code simply zero extended ax into dx before doing the division (presumably the variables are all unsigned).

## 6.5 Logical, Shift, Rotate, and Bit Instructions

This group of important instructions includes `and`, `or`, `xor`, `not`, `ror`, `rol`, `rcr`, `rcl`, `shl/sal`, `shr`, `sar`, `shrd`, `shld`, `bt`, `bts`, `btr`, `btc`, `bsf`, `bsr`, and `setcc`. Their syntax is

```

AND     dest, source
OR      dest, source
XOR     dest, source
NOT     dest
SHL     dest, count   ;SAL is a synonym for SHL.
SHR     dest, count
SAR     dest, count
SHLD    dest, source, count
SHRD    dest, source, count
RCL     dest, count
RCR     dest, count
ROL     dest, count
ROR     dest, count
TEST    dest, source
BT      source, index
BTC     source, index
BTR     source, index
BTS     source, index
BSF     dest, source
BSR     dest, source
SETcc   dest           ;See textbook for cc.

```

The `and`, `or`, `xor`, and `not` instructions perform bitwise logical operations on their operands allowing you to clear selected bits, set selected bits, invert selected bits, or invert all the bits in their destination operands.

If you only consider the value of a single bit in their operands, then you can treat these operations like the boolean operators in Pascal or C. However, a common mistake is to “mix metaphors” when using these instructions. For example, C programmers often treat zero as false and anything else as true. In particular, most programmers use one for true and zero for false. One must be careful, however, because “not 1” does not equal false, it equals 0FEh which is true! Likewise, 0AAh (true) logically ANDed with 55h (true) is equal to zero (false).

### 6.37 One way to convert these instructions to “boolean logical instructions” is to use only bit zero for true and false and reset all other bits to zero after each operation. Which of the log

**ical operations can you use to force all bits except bit zero to the value zero? What operand would you use with this logical operation to accomplish this?**

5.32 If you negate zero it produces zero and sets the zero flag.

**6.38 Given that A, B, C, D, and E are all Pascal boolean variables (bytes), what 80x86 code could you use to implement the following Pascal statement:**

**A := (B and C) or not (D and E);**

---



---



---



---

5.33 AX := BX \* 10

Despite their similarity to Pascal boolean operators, the `and`, `or`, `xor`, and `not` instructions are quite useful for decidedly non-boolean operations. In particular, you can use these instructions to set, clear, and invert arbitrary bits in an register or memory location. Recall the DATE data type from Chapter Two



5.34  
`imul bx, i, 6`  
`add bx, j`  
`imul bx, bx, 7`  
`add bx, k`  
`mov al, ThreeD[bx]`

Suppose `ax` contains a value in the range 1..31 which you wish to insert into the day field of this date structure. The first thing you will need to do is shift the days value seven positions to the left to align it with “DDDDD” field above. There are a couple of ways to do this. On 80286 and later processors the best way is probably to use the `shl reg, 7` instruction. Once you have shifted the value into place, you will need to replace the existing DDDDD field with the new data. Probably the easiest way to do this is to force the existing bits to zero and then logically OR in the new DDDDD data:

```
; Insert Day value in AX into the DDDDD field of the date structure
; in the BX register

        shl     ax, 7           ;Properly position day bits.
        and     bx, 0F07Fh     ;Clear existing DDDDD bits.
        or      bx, ax         ;Merge in the new day value.
```

5.35 Zero, one, or two.

The following code extracts the year and returns the current year if it is a leap year, otherwise it returns the previous leap year in `ax`. Note that this code does *not* work for the years 1900..1903 since 1900 was not a leap year. It does, however, work for 2000..2003.

```
; Return last leap year. Assume DATE value is in the AX
; register upon entering this section of code.

        and     ax, 7ch
```

Yes, that’s not a misprint. It only took one machine instruction. To bad the explanation of how it works is considerably longer!

ANDing the date value with `7Fh`, of course, strips out the year field and sets all other bits to zero. To get the previous leap year (or the current year if it is a leap year) all we’ve got to do is compute “Year - (Year MOD 4)”. If the current year is evenly divisible by four, “Year MOD 4” is zero and the calculation above returns the current year. If last year was a leap year, then

“Year MOD 4” is one, which subtracted from this year’s date produces a leap year. Likewise for the other two possibilities.

ANDing a value with 0FCh produces the same value. “AX MOD 4” always produces a value between zero and three, which fits nicely into two bits. If you force the L.O. two bits of ax to zero you effectively reset its value back to the last multiple of four, which is exactly what we want.

The and AX, 7ch combines the two AND operations into one: it masks out everything except the year field and it clears the two L.O. bits of the year field in a single operation.

One interesting use of the XOR operation is to exchange data between two operands. If you XOR anything with itself, you get zero. The following sequence of operations will swap the values A and B without using a temporary memory location:

```
A := A xor B;      B := A XOR B;      A := A XOR B;
```

Of course, on the 80x86 you can use the xchg instruction to swap two operands, however, suppose you want to swap the MONTH field in our data type with the value in the ax register. The following code will do this without using any extra registers. Try it!

```
ror    ax, 4        ;Assume month was 1..12.
xor    ax, Date
xor    Date, ax
xor    ax, Date
rol    ax, 4        ;Put month into range 1..12.
```

### 6.5.1 SHL, SHR, SAR, SHLD, SHRD, RCL, RCR, ROL, and ROR

The 80x86 shift instructions perform the following operations:

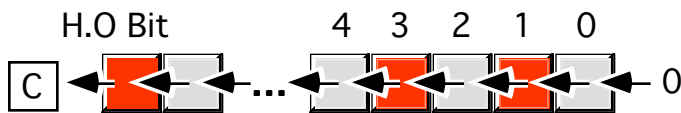

Shift Left Operation



Shift Right Operation

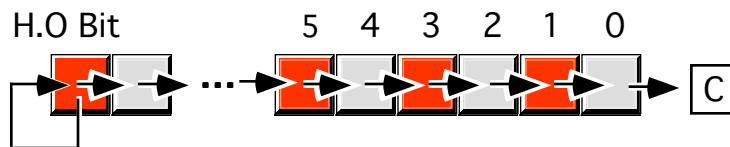

Arithmetic Shift Right Operation



5.36 Division by zero.

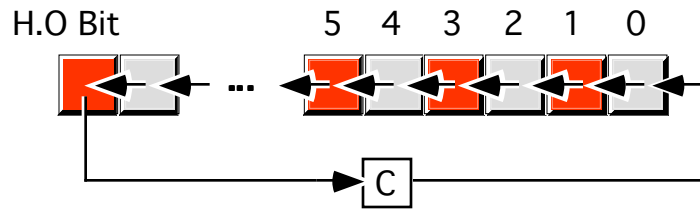
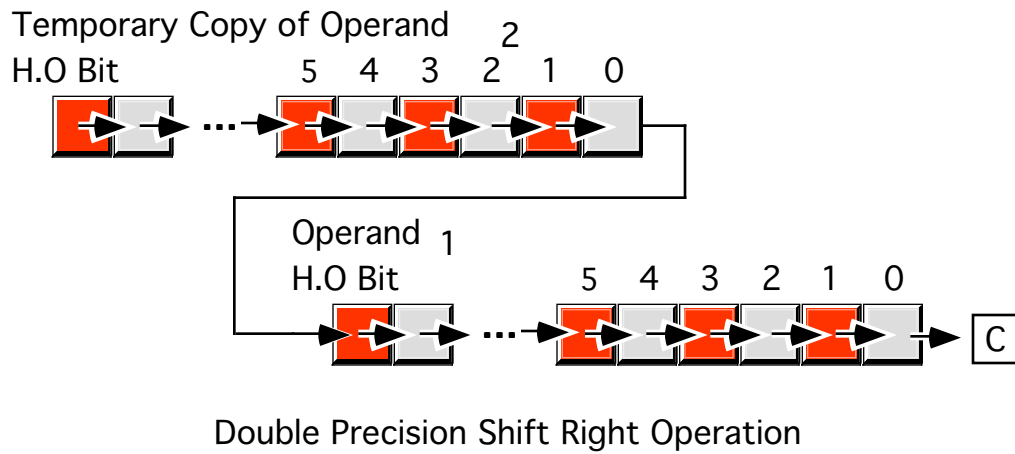
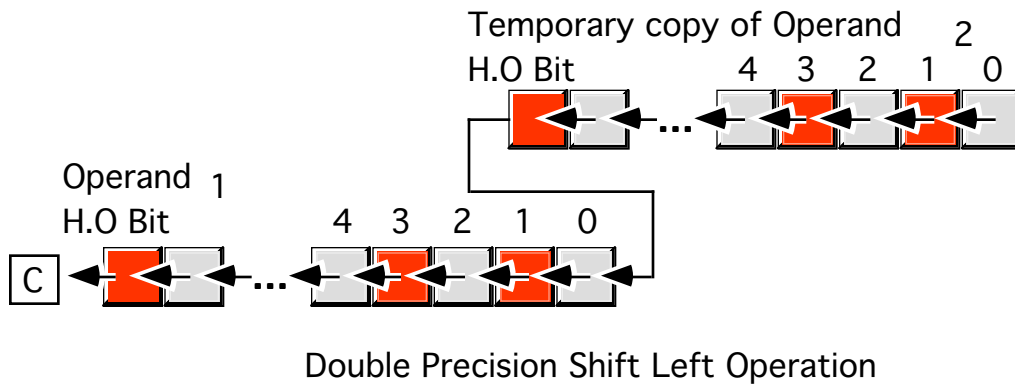

Rotate Through Carry Left Operation

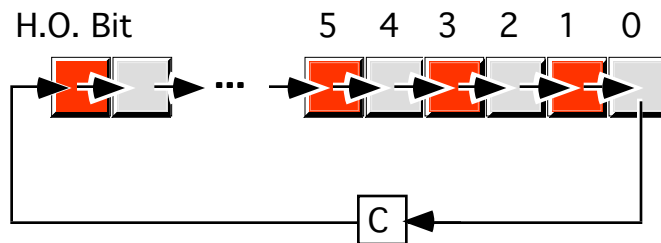

Rotate Through Carry Right Operation

5.37 AND, 1

5.38  
 mov al, b  
 and al, c  
 mov ah, d  
 and ah, e  
 not ah  
 and ah, 1  
 or al, ah  
 and al, 1  
 mov a, al

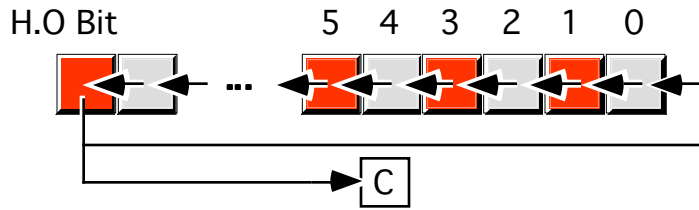

Rotate Left Operation

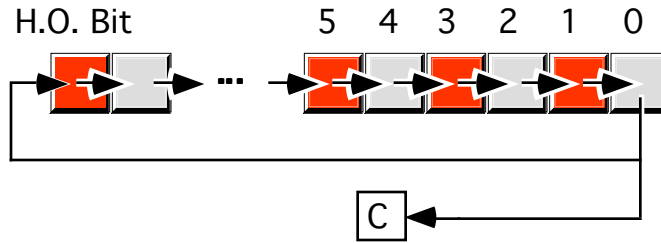

Rotate Right Operation

The syntax for these instructions is

```

shl  reg/mem, 1
shl  reg/mem, cl
shl  reg/mem, integer          (2)

sal  reg/mem, 1
sal  reg/mem, cl
sal  reg/mem, integer          (2)

shr  reg/mem, 1
shr  reg/mem, cl
shr  reg/mem, integer          (2)

sar  reg/mem, 1
sar  reg/mem, cl
sar  reg/mem, integer          (2)

shld reg/mem, reg, integer      (3)
shld reg/mem, reg, cl           (3)

shrd reg/mem, reg, integer      (3)
shrd reg/mem, reg, cl           (3)

rcl  reg/mem, 1
rcl  reg/mem, cl
rcl  reg/mem, integer          (2)

rcr  reg/mem, 1
rcr  reg/mem, cl
rcr  reg/mem, integer          (2)

rol  reg/mem, 1
rol  reg/mem, cl
rol  reg/mem, integer          (2)

ror  reg/mem, 1
ror  reg/mem, cl
ror  reg/mem, integer          (2)

```

(2) Available only on 80286 and later processors.

(3) Available only on 80386 and later processors.

The `shl` and `sal` mnemonics are synonyms. Note that `shl` by one bit corresponds to a multiplication by two. `Shr` and `sar` deal with unsigned and signed values, respectively. When shifting one bit to the right, they correspond to a division by two.

**6.39** What instruction(s) could you use to multiply the value in `AX` by four? (Hint: don't use `ADD`, `MUL` or `IMUL`)

---

**6.40** When dividing an integer value by two, it's quite possible that you will end up with an inexact result (when dividing an odd number by two). How can you test after `SAR/SHR` to see if you've obtained an inexact result?

---



---

**6.41** How can you use the `AND` instruction to convert `AX` to zero if it is even, one if it is odd?

---

The rotate instructions come in handy when you need to pack several values into a single byte, word, or double word. For example, suppose you have four bytes and merge bits two and three from each of these four bytes into a single byte. You could use the following code to accomplish this:

```

mov     ah, Byte1
and     ah, 00001100b      ;Mask out our bits.
rol     ah, 2              ;Move them over!
mov     al, Byte2
and     al, 00001100b      ;Mask out other bits.
or      ah, al             ;Merge into value.
rol     ah, 2
mov     al, Byte3
and     al, 00001100b
or      ah, al
rol     ah, 2
mov     al, Byte4
and     al, 00001100b
or      ah, al

```

The code above shifts `Byte1`, `Byte2`, `Byte3`, and `Byte4` into `ah` as follows:

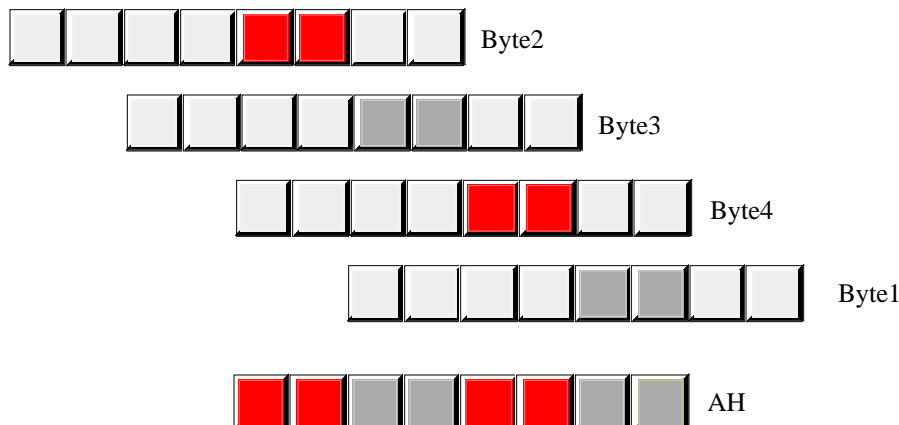

---

## 6.5.2 TEST

The test instruction logically ANDs its two operands but does not store the result in the destination operand. It simply sets the flags according to the result of the logical AND operation.

```
test    dest, source
```

**6.42** What other instruction works in a non-destructive fashion like TEST? What is the operation it performs?

---

**6.43** Explain how you use the TEST instruction to see if the value in AX is even or odd. Why is this method better than using the AND instruction?

---



---



---

You can use the test instruction to check the value of an individual bit within some value. If one of the operands contains a single set bit, then test will set the zero flag if the corresponding bit in the other operand is zero; it will clear the zero flag if that corresponding bit contains a one. Therefore, you can use the test instruction to see if an individual bit is set or clear.

Another common use of the test instruction is to see if a group of bits in some value are all zero. If one of the operands contains one bits in all the positions you require zeros in the second operand, the CPU will set the zero flag only if all the corresponding bits are zero. For example, and al, 0fh sets the zero flag only if bits zero through three of al contain zeros.

---

## 6.5.3 BT, BTS, BTR, and BTC

The Bit Test (bt), Bit Test and Set (bts), Bit Test and Reset (btr), and Bit Test and Complement (btc) instructions also let you test individual bits. The second operand of these instructions specifies a bit number (0..31) in the first operand. They copy that bit into the carry flag so you can test the carry flag afterwards. The bts, btr, and btc instructions also set, clear, or complement the bit after copying it into the carry flag. These instructions are available only on 80386 and later processors. Their syntax is

```
bt      reg/mem, reg
bt      reg/mem, integer

bts     reg/mem, reg
bts     reg/mem, integer

btr     reg/mem, reg
btr     reg/mem, integer

btr     reg/mem, reg
btr     reg/mem, integer
```

The bt instruction provides a convenient way to test an individual bit within some value. This is usually more straight forward than using the test instruction since you can specify the exact bit you want to test rather than a binary mask. The bts, btr, and btc instructions let you easily manipulate *flags* (boolean variables). For example, suppose you want to test a boolean variable to see if it is false and set it to true regardless of its current setting. You can easily accomplish this with a single bts instruction:

```
bts     flag, 0           ;Assume value is in bit zero.
```

One use for the btr instruction is to perform an n-bit rol operation. Consider the following code which rotates six bits to the right in AL:

```

btr    al, 5      ;Bit #5->carry, set to zero.
rcl    al, 1      ;Copy carry to bit zero, etc.
bt     al, 0      ;Set carry to original value.
    
```

5.39 SHL AX, 2 (on 80286 or later) or the sequence:

```

SHL AX, 1
SHL AX, 1
    
```

The btr instruction copies bit five into the carry flag and then clears bit five. The rcl instruction rotates the data in al one position to the left and copies the carry flag into bit zero. The bt instruction copies the rotated bit back into the carry flag, producing the desired result:

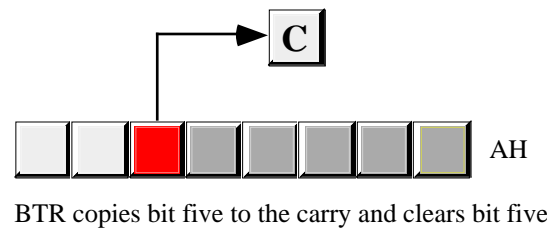
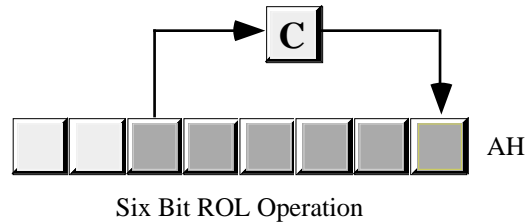

5.40 Look at the carry flag. If it's set the result is inexact.

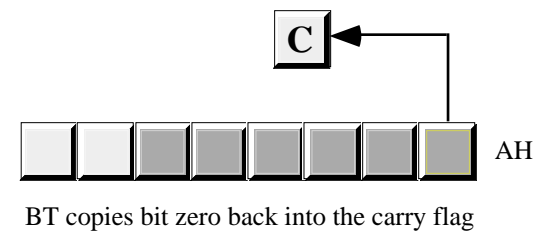
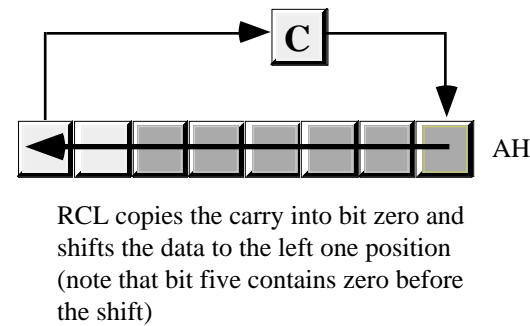

5.41 AND AX, 1

**6.44 Explain how you could use the BT and ADC instructions to round all odd numbers to the next higher even value:**

---



---

## 6.6 BSF and BSR

The `bsf` and `bsr` instructions look for the first set bit in an operand starting from bit zero (`bsf`) or the H.O. bit (`bsr`). They return (in the destination operand) the bit count of the position of the first set bit in the source operand:

```
bsf    reg, reg/mem
bsr    reg, reg/mem
```

These instructions scan through the `reg/mem` operand looking for the first set bit. They store the bit position of that bit in the `reg` operand. If the `reg/mem` operand is not zero (i.e., there is at least one set bit), then these instruction clear the zero flag. If the `reg/mem` operand is zero, these instructions set the zero flag and the `reg` operand contains an indeterminate result.

**6.45 BSF and BSR only look for the first set bit in a value. If you want to search for the first zero bit in a value, you must perform some operation on the data to convert all the zeros to ones and vice versa. What is this operation?**

**6.46 Suppose you want to clear the set bit detected by “BSR AX, Bits” immediately after executing the BSR instruction. What single instruction could you use to do this that uses the value in AX?**

### 6.6.1 SETcc

The `setcc` (set on condition) instructions test one or two bits in the flags register and then store a byte containing zero or one in the destination operand depending on the status of the flag bit(s). This instruction is quite useful for synthesizing complex boolean operations. `setcc` tests the following conditions: `setc` (carry set), `setnc` (carry clear), `setz` (zero flag set), `setnz` (zero flag clear), `sets` (sign flag set), `setns` (sign flag clear), `seto` (overflow flag set), `setno` (overflow flag clear), `setp` (parity flag set), `setnp` (parity flag clear), `seta` (unsigned greater than), `setae` (unsigned greater or equal), `setb` (unsigned less than), `setbe` (unsigned less than or equal), `sete` (equal), `setne` (not equal), `setg` (signed greater than), `setge` (signed greater or equal), `setl` (signed less than), and `setle` (signed less than or equal). There are some aliases for these instructions as well, see the textbook for details. These instructions are available only on 80386 and later processors.

You can use the `setcc` instructions to easily perform complex boolean computations. Consider the following Pascal statement:

```
B := ((i = j) and (k <= l)) or (m <> n);
```

This Pascal code easily converts to the following 80386 code using the `setcc` instructions:

```
mov    ax, i        ;BL := i = j
cmp    ax, j
sete   bl
mov    al, k        ;BH := k <= l
cmp    ax, l
setle  bh
and    bl, bh       ;BL := BL and BH
mov    ax, m        ;BH := m <> n
cmp    ax, n
setne  bh
or     bl, bh       ;BL := BL or BH
mov    b, bl        ;b := bh
```

Since `setcc` always produces zero or one, you can use the `and`, `or`, and `xor` instructions to perform the corresponding boolean operations. Keep in mind, however, that if you want to use the `not` operation to negate a boolean value, you will need to follow it up with an `and` to remove the unnecessary bits.

**6.47 To perform the boolean not operation on a multi-bit value, you really only want to invert the L.O. bit, not all the bits like the NOT operation. What instruction can you use to invert only the L.O. bit?**

---

## 6.7 The I/O Instructions

The 80x86 provides four I/O instructions: `in`, `out`, `ins`, and `outs`. The `in` and `out` instructions read data from the I/O address space (`in`) and write data to the I/O address space (`out`). We'll consider `ins` and `outs` in the next section.

There are two forms of the `in` and `out` instructions:

```
in    al, port
in    al, dx
out   port, al
out   dx, al
```

The `port` operand is an eight-bit constant in the range 0..255. The 80x86 CPU family supports up to 65,536 different I/O locations. The instructions utilizing the `port` address operand can only address the first 256 locations in this 16-bit I/O address space. To access the other locations you must load the address into the `dx` register and utilize the `in/out` instructions with the `dx` operand.

The IBM PC printer port typically appears at address 378h in the I/O address map. You can output data to the LPT port by writing a byte to this I/O address. The following 80x86 code will store the character 'A' on the printer port data lines:

```
mov   dx, 378h
mov   al, 'A'
out   dx, al
```

**6.48 You can read the last byte written to the parallel port using the IN instruction. What sequence of instructions would you use to read the 'A' written above from the parallel port?**

---

Please note that the above instructions are not sufficient if you actually want to print a character to the printer on the parallel port. The `in` and `out` instructions simply set up the data for the printer to print. Additional instructions (which we'll discuss in a later chapter) are necessary to actually print data to the printer.

## 6.8 The String Instructions

The 80x86 string instructions manipulate blocks of bytes in memory. Indeed, they are the only instructions which allow you to directly move data from one memory location to another or compare one memory location to another without going through any registers. However,

5.42 `CMP, SUB`5.43 `TEST AL, 1` (or `TEST AX, 1`) sets the zero flag if the number is even. This is better than `AND` because it is non-destructive.5.44 Assuming the value is in `AX`:  
`BT AX, 0`  
`ADC AX, 0`

because of the setup involved when using these instructions, you would not normally use them to manipulate just a few bytes. They are best utilized to manipulate large blocks of data.

The string instructions perform the following operations:

```

MOVS{b,w,d}:    ES:[DI] := DS:[SI]
                if direction_flag = 0 then
                    SI := SI + size;
                    DI := DI + size;
                else
                    SI := SI - size;
                    DI := DI - size;
                endif;

LODS{b,w,d}:    EAX/AX/AL := DS:[SI]
                if direction_flag = 0 then
                    SI := SI + size;
                else
                    SI := SI - size;
                endif;

STOS{b,w,d}:    ES:[DI] := EAX/AX/AL
                if direction_flag = 0 then
                    DI := DI + size;
                else
                    DI := DI - size;
                endif;

CMPS{b,w,d}:    CMP DS:[SI], ES:[DI]      ;Set appropriate flags.
                if direction_flag = 0 then
                    SI := SI + size;
                    DI := DI + size;
                else
                    SI := SI - size;
                    DI := DI - size;
                endif;

SCAS{b,w,d}:    CMP EAX/AX/AL, ES:[DI]    ;Set appropriate flags.
                if direction_flag = 0 then
                    DI := DI + size;
                else
                    DI := DI - size;
                endif;

INS{b,w,d}:     ES:[DI] := port(DX)
                if direction_flag = 0 then
                    DI := DI + size;
                else
                    DI := DI - size;
                endif;

OUTS{b,w,d}:    port(DX) := DS:[SI]
                if direction_flag = 0 then
                    SI := SI + size;
                else
                    SI := SI - size;
                endif;

```

*size* = 1, 2, or 4 for bytes, words, or double words.



Although the term “string instructions” conjures up some magic operations you can use to manipulate character strings, there is nothing about these instructions that limits them to manipulating character strings. Indeed, you’ll use these instructions for other data types as often as you use them to manipulate character strings.

Consider the `movs` instruction. Successively executing this instruction copies data from one array to another. For example, if you have an array of 16 words, the following code will copy data from one array to another:

```
Ary1Ptr      dword  Array1
Ary2Ptr      dword  Array2
.
.
.
lds         si, Ary1Ptr
les         di, Ary2Ptr
mov         cx, 16
CopyArray:  movsw
            loop  CopyArray
```

Using a string instruction in a loop as above is so common that Intel created a special *prefix* instruction which merges the loop instruction above into the `movs` instruction. If you place the `rep` (repeat) prefix just before the `movsw` above, you do not need the loop instruction:

```
lds         si, Ary1Ptr
les         di, Ary2Ptr
mov         cx, 16
rep        movsw
```

The `lodsb` and `stosb` instructions, executed together, perform the same operation as the `movs` instruction<sup>5</sup>. That is, the following loop does the same work as the `rep movsb` instruction:

```
DoMOVS:    lodsb
            stosb
            loop  DoMOVS
```

Since the `lodsb/stosb` method is bigger and slower, you might be wondering why anyone would want to use this sequence. Well, the main reason is because you can insert additional instructions between the `lodsb` and `stosb` instructions. For example, you could place the `xlat` instruction between them to perform some data translation while copying one array of bytes to another (e.g., convert all the characters in one string to uppercase while moving them).

```
ConvertLoop:  mov     cx, SizeOfString
              lodsb
              cmp     al, 'A'           ;convert upper case to
              jb     NotAlpha         ; lower case letters.
              cmp     al, 'Z'
              ja     NotAlpha
              and     al, 0Bfh        ;Clear bit 6 (see chapter one).
NotAlpha:    stosb
              loop  ConvertLoop
```

**6.49** Although it is legal to use the `REP` prefix with the `LODS` instruction, doing so doesn’t make much sense. Why? (Hint: what happens if you execute two `LODSB` instructions in a row?)

---



---

5.45 NOT

5.46 BTR Bits, AX

5.47 XOR. Assuming the value is in AX you could use the instruction `XOR AX, 1` to invert only the L.O. bit.

Another possibility is to use the instruction: `btc ax, 0`

5.48  
`mov dx, 378h`  
`in al, dx`

5. Except, of course, the `LODS/STOS` instruction pair modify the `AL/AX/EAX` register while `MOVS` does not.

Though you wouldn't ever want to use the REP prefix with the lods instruction, it makes perfect sense to use it with the stos instruction. You can use rep to force stos to fill an array with a single value. For example, the following code zeros out the 16-element integer array pointed at by Ary1Ptr:

```

        les     di, Ary1Ptr
        mov     cx, 16
        mov     ax, 0
rep     stosw

```

You'll get a chance to see how the other string instructions work with the REP/REPE/REPNE prefixes in the chapter on string instructions.

## 6.9 Unconditional Jumps

The unconditional jump instructions transfer control to the instruction specified by the operand of the jump. Unlike most HLLs, the 80x86 jmp instruction provides many different types of jump operations. The reason is quite simple: most HLLs want to discourage the programmer from using gotos, especially fancy ones. However, the compilers themselves need to generate fancy goto/jmp operations in order to convert high-level structures (like case/switch, while, etc.) into machine code.

80x86 jmp instructions come in two basic categories: near (intra-segment) and far (inter-segment). The near jmp instructions can transfer control to any statement within the current code segment. These instructions simply copy their operand into the ip register. They allow the following syntactical variations:

```

        jmp     disp
        jmp     reg
        jmp     mem16

```

### 6.50 In many respects, the JMP instruction is really just another form of the MOV instruction. Explain:

---



---

Near jmp operands can be an immediate value, a 16-bit general purpose register, or a 16-bit memory location (addressed by any of the 80x86's addressing modes). If an immediate operand is present, MASM converts it to an eight-bit or 16-bit signed displacement that provides the distance from the jmp instruction to the target location. If you specify a register operand, the jmp instruction simply copies the data from the specified register into ip. If you specify a memory location, using a memory addressing mode, the jmp instruction copies the 16 bits from the specified memory location into ip.

### 6.51 What is the difference between the "JMP BX" and "JMP [BX]" instructions? Explain what each of these do:

---



---



---



---

The far jmp copies its operand into the cs:ip register pair. It behaves like an "lcs ip,operand" instruction. If the operand is an immediate value, it provides the full segment:offset address of the target location; this is not a displacement to the target. If the operand of a far jmp is a memory location, then it is a double word value providing the segment (in the H.O. word) and offset (in the L.O. word) of the target location. There is no far jmp instruction that uses register operands.

Most `jmp` instructions are near jumps with an immediate operand. The chapter on control structures in the textbook goes into the gory details of how you would use the other forms of the `jmp` instruction. In general, it's best if you avoid the indirect jumps (those using memory or register operands) since they can make your programs much harder to read and maintain.

5.49 Doing so would load each new value over the top of the old value in AL/AX/EAX. Hence you would lose the results of all but the last operation.

---

## 6.10 The CALL and RET Instructions

The `CALL` and `RET` instructions provide the mechanism for implementing procedures, functions, and other types of program units.

The `call` instruction pushes a *return address* onto the stack and then jumps to the address given by its operand. Other than the fact that `call` pushes the address of the instruction following the `call` onto the stack, it behaves exactly like the `jmp` instruction.

One minor complication is that the near and far `call` instructions push different values on the stack. The near `call` pushes a 16-bit offset into the current code segment onto the stack before doing a near jump. The far `call` pushes a 32-bit return address, `cs` followed by the offset, onto the stack.

The `ret` instruction pops the return address off the stack and transfers control to that address. There are two types of return instructions: near and far. The near return instruction simply pops a 16-bit value off the stack into the `ip` register. The far return instruction pops a 16-bit value into `ip` and a second 16-bit value into `cs`. There are two other forms of the return instruction, we will consider their operation in Chapter Nine.

---

## 6.11 The INT, INTO, BOUND, and IRET Instructions

The `into`, `bound`, and `iret` instructions are advanced instructions which require an understanding of the 80x86 interrupt structure prior to using them. For that reason, we will not consider these instructions again until the chapter on interrupts and concurrency. In general, the same could be said for the `int` instruction except that the IBM PC system uses the `int` instruction to transfer control to DOS and other system related routines. One does not need to know how the `int` instruction operates to use it to make calls to MS-DOS or the PC's ROM BIOS routines.

The ROM BIOS (Basic Input/Output System) on the IBM PC provides a routine you can use to test and read data from the keyboard. Although the exact entry point in the ROM is not guaranteed, you can call the routine wherever it sits in memory using the `int 16h` instruction. Loading `ah` with zero prior to executing `int 16h` instructs the BIOS routine to read a key from the keyboard (and not return from `INT 16h` until you press a key) and return the ASCII code for that key in `al`. Likewise, BIOS uses the `int 10h` instruction with `ah=0Eh` to print the character in `al` to the video display. So the following loop reads characters from the keyboard until the user presses the  key (ASCII code is 0dh) and displays those characters on the video display:

```
ReadLoop:      mov     ah, 0
               int     16h           ;Read a key from keyboard.
               mov     ah, 0eh
               int     10h           ;Write char to display.
               cmp     al, 0dh        ;See if ENTER key.
               jne     ReadLoop       ;Repeat if not ENTER.
```

For more information about the interrupt routines that DOS and BIOS support, see the chapter on BIOS and DOS in your textbook.

## 6.12 The Conditional Jump Instructions

The conditional jump instructions are some of the most important instructions in the 80x86 instruction set. These instructions let your programs make decisions. These `Jcc` instructions (there is a corresponding `JCC` instruction to every `SetCC` instruction) test one or two bits in the flags register and transfer control to a target location if the condition is true. If the condition is not true, control falls through to the next instruction after the conditional jump.

Valid `Jcc` instructions include `jc`, `jnc`, `jz`, `jnz`, `js`, `jns`, `jo`, `jno`, `jp`, `jnp`, `ja`, `jae`, `jb`, `jbe`, `je`, `jne`, `jl`, `jge`, `jl`, and `jle` (there are some other aliases as well, see your textbook). These instructions test the same conditions as the `setCC` instructions. See that section for more details.

The `JCC` instructions are particularly useful after the `cmp` instruction to check the result of the that operation. Together, the `cmp` and `JCC` instructions let you synthesize IF/THEN/ELSE instructions and loops like WHILE or REPEAT/UNTIL. For example, the following code adds 5 to `ax` if `ax` is less than `bx`:

```

cmp    ax, bx
jnb    SkipAdd
add    ax, 5

```

SkipAdd:

### 6.52 Write a short code segment which swaps the values in AX and BX if AX is less than BX:

---



---



---



---

The 8086-80286 `JCC` instructions will jump a maximum of  $\pm 128$  bytes around the current instruction. If the branch is out of range the easiest resolution is to convert it to a pair of jumps, the opposite `JCC` instruction jumping around a `jmp` to the actual target location. Generally, MASM versions 6.0 and later will automatically convert an out of range `JCC` for you. Once in a while it will fail on you, however. Furthermore, you may need to perform this conversion manually yourself if you are not using an assembler which converts out of range jumps. The following code demonstrates how to translate an out of range `JC` instruction to one which will work fine:

Original Code:

```

shl    ax, 1
jc     OutOfRange

```

Converted Code:

```

shl    ax, 1
jnc    SkipMe
jmp    OutOfRange

```

SkipMe:

### 6.53 Suppose that the instruction “JE RepeatLoop” is out of range. What is the code that will correct this problem?

---



---



---

In general, most programmers use `je/jne` after a `cmp` instruction and they use `jz/jnz` after most other instructions which affect the zero flag. Of course, you could use `je/jz` or `jne/jnz` interchangeably but good programming style mandates that you use these instructions where appropriate. For example, the `cmp` and `sub` instructions set the zero

flag in exactly the same way. However, it makes sense to talk about two operands being *equal* after a `cmp` or a subtraction producing a *zero* result. Hence you'll normally use `je/jne` after `cmp` and `jz/jnz` after `sub`. Here are some examples:

```

cmp    ax, 1                ;See if AX = 1.
je     AXisOne

test   al, 1                ;See if bit zero is one.
jnz    Bit0Is1

test   ax, ax              ;See if AX = 0.
jz     AXisZero

inc    ax                  ;See if AX overflows
jz     Overflow

```

`Jc` and `jnc`, and their synonyms `jb` and `jnb` are also very common in assembly language programs. Since many instructions affect the carry flag (e.g., arithmetic, shift, and rotate instructions) you'll often use `jc` and `jnc`. Like `je/jnz` you will typically use `jb/jnb` after a compare instruction.

```

cmp    al, 'A'             ;See if AL < 'A'
jb     NotAlpha

shr    ax, 1               ;Move L.O. bit into carry
jc     LOBitIsSet         ; and branch if set.
shr    ax, 1               ;Now move bit #1
jc     Bit1IsSet         ; into carry and branch
etc.                       ; if set.

```

The 80x86 conditional branch instructions are quite useful for synthesizing loops and IF..THEN..ELSE statements. But that is a subject for another chapter.

5.50 It moves its operand into the IP register.

5.51 `JMP BX` jumps to the memory location whose address is in `BX`. The `JMP` word ptr `[bx]` jumps to the address specified by the word at memory location `DS:[bx]`.

## 6.13 The `JCXZ` and `LOOPxx` Instructions

The 80x86 provides four instructions which manipulate and test the `CX` register and then conditionally branch to some target location: `jcxz/jecxz`, `loop`, `loope`, and `loopne`.

`Jcxz` checks the `CX` (`ECX` for `Jecxz`) register to see if it is zero. If so, `JCXZ` transfers control to the target address, if `CX` is not zero, control transfers to the next instruction after `JCXZ`. `JCXZ` is particularly useful in conjunction with the `loop` instruction (described next) to handle the case when `CX` is zero.

The `loop` instruction decrements `CX` and then branches to the target location if `CX` is not zero. *Note that the test for `CX=0` occurs after the decrement operation.* If `CX` is zero when you first execute the `loop` instruction, `loop` decrements `CX` (producing `0FFFFh`) which is not zero so control transfers to the specified target location. E.g., the following loop will execute 65,536 times:

```

; Presumably CX contains zero at this point...

LoopToHere:    mov    [bx], ax
               add    bx, 7
               loop   LoopToHere

```

### 6.54 Fix the above loop so that it will not execute 65,536 times if CX turns out to be zero upon entering the loop:

---



---



---



---



---

The loop and loopne instructions also decrement cx and fall through if cx is zero, but they also test the zero flag to determine if the branch should be taken. The following code reads up to 80 characters unless a carriage return comes along before then:

```

ReadTillCR:    mov     cx, 80
               mov     ah, 0           ;Read a character
               int     16h           ; from the keyboard
               <do something with AL>
               cmp     al, 0dh        ;See if return
               loopne  ReadTillCR

```

The printer port *busy* flag is bit seven of input port 379h on many systems. A *printer spooler* program under MS-DOS will often check for some period of time to see if the printer is busy. If it remains busy for an extended period of time DOS will continue other processing. However, if it clears the busy bit after a period, the printer spooler will send another character to the printer. The following code demonstrates how to do this with the LOOPNE instruction:

```

TestBusy:     mov     cx, 4000h       ;Time to wait for busy.
               mov     dx, 379h      ;Printer status port.
BusyLoop:    in     al, dx           ;Get printer port status.
               test    al, 80h       ;Test the busy bit.
               loopne BusyLoop      ;Repeat while busy
               jne     StillBusy
               <Output another char here>
               jmp     TestBusy      ;Try again
StillBusy:

```

---

## 6.14 Miscellaneous Instructions

The 80x86 provides several additional instructions you can use to manipulate various flags and otherwise control the operation of the CPU. These instructions include clc (clear carry), stc (set carry), cmc (complement carry), cld (clear direction flag), std (set direction flag), cli (clear interrupt flag), sti (set interrupt flag), nop (no operation), and hlt.

The nop instruction is really a synonym for the xchg ax,ax instruction. This is a one byte instruction which doesn't affect any registers or flags and consumes one to three clock cycles (depending on the processor). The main purpose for this instruction is to "punch out" instructions in memory while using a debugger like CodeView. If you discover that you've got an instruction you don't want in the object code, you can replace each byte of the instruction with a nop byte (opcode = 90h) and the program will continue to function assuming it doesn't have any real tight timing dependencies.

The hlt instruction stops the CPU dead in its tracks. After executing hlt, only hardware interrupts and the reset line are operational. For a typical PC system, if you execute hlt you will need to reboot the machine.

## 6.15 Using MASM and LINK

In the laboratory exercises for this chapter you will need to use MASM and LINK to assemble the output produced by the IBM/L (Instruction Bench Marking Language) system. This section describes some of the steps you will need to follow to use MASM with the IBM/L system.

Assuming no special file dependencies, using MASM 6.x is very easy. Just type

```
ml name.asm
```

and you're in business. MASM will assemble and link your program producing an ".EXE" executable file.

In the laboratory you will link the output of the IBM/L compiler with some routines in the UCR Standard Library. If you've installed the UCR Standard Library routines on your hard disk (the Standard Library code appears on the disk accompanying this manual) then you need to execute the following DOS commands to properly set MASM's *include* and *lib* paths:

```
SET INCLUDE=C:\STDLIB\INCLUDE
SET LIB=C:\STDLIB\LIB
```

Of course, if you've placed the standard library "include" and "lib" files in directories other than those listed above, you will need to make the appropriate changes to these DOS commands. Furthermore, if you use another Microsoft language or some other system that needs include and lib paths set up, you may need to adjust the above lines for those languages as well. Please see the manual accompanying those other languages.

Another possibility is to copy all the include and lib files from the UCR Standard Library into your working directory. However, this tends to clutter your working directory. You should only use this approach if you cannot modify the include or lib path for one reason or another.

## 6.16 IBM/L (Instruction Benchmarking Language)

IBM/L lets you time sequences of instructions to see how much time they *really* take to execute. The cycle timings in most 80x86 assembly language books are horribly inaccurate as they assume the absolute best case. IBM/L lets you try out some instruction sequences and see how much time they actually take. This is an invaluable tool to use when optimizing a program. You can try several different instruction sequences that produce the same result and see which sequence executes fastest.

IBM/L uses the system 1/18th second clock and measures most executions in terms of clock ticks. Therefore, it would be totally useless for measuring the speed of a single instruction (since all instructions execute in *much* less than 1/18th second). IBM/L works by repeatedly executing a code sequence thousands (or millions) of times and measuring that amount of time. IBM/L automatically subtracts away the loop overhead time.

IBM/L is a compiler which translates a source language into an assembly language program. Assembling and running the resulting program benchmarks the instructions specified in the IBM/L source code and produces relative timings for different instruction sequences. An IBM/L source program consists of some short assembly language sequences and some control statements which describe how to measure the performance of the assembly sequences. An IBM/L program takes the following form:

```
5.52
    cmp ax, bx
    jae NoSwap
    xchg ax, bx
NoSwap:
```

```
5.53
    je Skip
    jmp RepeatLoop
Skip:
```

```

#data          <variable declarations>
#enddata

#unravel <integer constant>
#repetitions <integer constant>
#code ("title")
%init
    <initial instructions whose time does not count>
%eachloop
    <Instructions repeated once on each loop, ignoring time>
%discount
    <instructions done for each sequence, ignoring time>
%do
    <statements to time>
#endcode

<Additional #code..#endcode sections>

#end

```

Note: the %init, %eachloop, and %discount sections are optional.

IBM/L programs begin with an optional data section. The data section begins with a line containing "#DATA" and ends with a line containing "#ENDDATA". All lines between these two lines are copied to an output assembly language program inside the dseg data segment. Typically you would put global variables into the program at this point.

Example of a data section:

```

#DATA
I           word   ?
J           word   ?
K           dword  ?
ch         byte   ?
ch2        byte   ?
#ENDDATA

```

These lines would be copied to a data segment the program IBM/L creates. These names are available to *all* #code..#endcode sequences you place in the program.

Following the data section are one or more code sections. A code section consists of optional #repetition and #unravel statements followed by the actual #code..#endcode sections.

The #repetition statement takes the following form:

```
#repetition integer_constant
```

(The "#" must be in column one). The integer constant is a 32-bit value, so you can specify values in the range zero through two billion. Typical values are generally less than a few hundred thousand, even less on slower machines. The larger this number is, the more accurate the timing will be; however, larger repetition values also cause the program IBM/L generates to run much slower.

This statement instructs IBM/L to generate a loop which repeats the following code segment *integer\_constant* times. If you do not specify any repetitions at all, the default is 327,680. Once you set a repetitions value, that value remains in effect for all following code sequences until you explicitly change it again. The #repetition statement must appear outside the #code..#endcode sequence and affects the #code section(s) following the #repetition statement.

If you are interested in the straight-line execution times for some instruction(s), placing those instructions in a tight loop may dramatically affect IBM/L's accuracy. Don't forget, executing a control transfer instruction (necessary for a loop) flushes the pre-fetch queue and has a big effect on execution times. The #unravel statement lets you copy a block of code several times inside the timing loop, thereby reducing the overhead of the conditional jump and other loop control instructions. The #unravel statement takes the following form:

```
#unravel count
```

(The "#" must be in column one). *Count* is a 16-bit integer constant that specifies the number of times IBM/L copies the code inside the repetition loop.



Note that the specified code sequence in the `#code` section will actually execute (*count* \* *integer\_constant*) times, since the `#unravel` statement repeats the code sequence *count* times inside the loop.

In its most basic form, the `#code` section looks like the following:

```
#CODE ("Title")
%DO
    <assembly statements>
#ENDCODE
```

The title can be any string you choose. IBM/L will display this title when printing the timing results for this code section. IBM/L will take the specified assembly statements and output them inside a loop (multiple times if the `#unravel` statement is present). At run time the assembly language source file will time this code and print a time, in clock ticks, for one execution of this sequence.

Example:

```
#unravel 16                16 copies of code inside the loop
#repetitions 960000        Do this 960,000 times
#code ("MOV AX, 0 Instruction")
%do
    mov    ax, 0
#endcode
```

The above code would generate an assembly language program which executes the `mov ax,0` instruction  $16 * 960000$  times and report the amount of time that it would take.

Most IBM/L programs have multiple code sections. New code sections can immediately follow the previous ones, e.g.,

```
#unravel 16                16 copies of code inside loop
#repetitions 960000        Do the following code 960000 times
#code ("MOV AX, 0 Instruction")
%do
    mov    ax, 0
#endcode

#code ("XOR AX, AX Instruction")
%do
    xor    ax, ax
#ENDCODE
```

The above sequence would execute the `mov ax, 0` and `xor ax, ax` instructions  $16 * 960000$  times and report the amount of time necessary to execute these instructions. By comparing the results you can determine which instruction sequence is fastest.

Any statement that begins with a semicolon in column one is a comment which IBM/L ignores. It does not write this comment to the assembly language output file.

All IBM/L programs must end with a `#end` statement. Therefore, the correct form of the program above is

```
#unravel 16
#repetitions 960000
#code ("MOV AX, 0 Instruction")
%do
    mov    ax, 0
#endcode
#code ("XOR AX, AX Instruction")
%do
    xor    ax, ax
#ENDCODE
#END
```

```
5.54
    jcz skiploop
LoopToHere:
    mov [bx], ax
    add bx, 7
    loop LoopToHere
skiploop:
```

An example of a complete IBM/L program using all of the techniques we've seen so far is

```
#data
        even
i        word  ?
        byte  ?
j        word  ?
#enddata

#unravel 16
#repetitions 32, 30000
#code ("Aligned Word MOV")
%do
        mov    ax, i
#endcode

#code ("Unaligned word MOV")
%do
        mov    ax, j
#ENDCODE
#END
```

There are a couple of optional sections which may appear between the `#code` and the `%do` statements. The first of these is `%init` which begins an initialization section. IBM/L emits initialization sections before the loop, executes this code only once. It does not count their execution time when timing the loop. This lets you set up important values prior to running a test which do not count towards the timing. E.g.,

```
#data
i        dword  ?
#enddata
#repetitions 100000
#unravel 1
#code
%init
        mov    word ptr i, 0
        mov    word ptr i+2, 0
%do
        mov    cx, 200
lbl:     inc    word ptr i
        jnz    NotZero
        inc    word ptr i+2
NotZero: loop  lbl
#endcode
#end
```

Sometimes you may want to use the `#repetitions` statement to repeat a section of code several times. However, there may be some statements that you only want to execute once on each loop (that is, without copying the code several times in the loop). The `%eachloop` section allows this. Note that IBM/L does not count the time consumed by the code executed in the `%eachloop` section in the final timing.

Example:

```
#data
i        word  ?
j        word  ?
#enddata

#repetitions 40000
#unravel 128
#code
%init -- The following is executed only once
        mov    i, 0
        mov    j, 0
```

```

%eachloop -- The following is executed 40000 times, not 128*40000 times
        inc    j
%do -- The following is executed 128 * 40000 times
        inc    i

#endcode
#end

```

In the above code, IBM/L only counts the time required to increment i. It does not time the instructions in the %init or %eachloop sections.

The code in the %eachloop section only executes once per loop iteration. Even if you use the #unravel statement (the inc i instruction above, for example, executes 128 times per loop iteration because of #unravel). Sometimes you may want some sequence of instructions to execute like those in the %do section, but not count their time. The %discount section allows for this. Here is the full form of an IBM/L source file:

```

#DATA
        <data declarations>
#ENDDATA
#REPETITIONS value1, value2
#UNRAVEL count
#CODE
%INIT
        <Initialization code, executed only once>
%EACHLOOP
        <Loop initialization code, executed once on each pass>
%DISCOUNT
        <Untimed statements, executed once per repetition>
%DO
        <The statements you want to time>
#ENDCODE
<additional code sections>
#END

```

To use this package you need several files. IBMLEXE is the executable program. You run it as follows:

```
c:> IBML filename.IBM
```

This reads an IBML source file (filename.IBM, above) and writes an assembly language program to the standard output. Normally you would use I/O redirection to capture this program as follows:

```
c:> IBML filename.IBM >filename.ASM
```

Once you create the assembly language source file, you can assemble and run it. The resulting EXE file will display the timing results.

To properly run the IBML program, you must have the IBMLINC.A file in the current working directory. This is a skeleton assembly language source file into which IBM/L inserts your assembly source code. Feel free to modify this file as you see fit. Keep in mind, however, that IBM/L expects certain markers in the file (currently “;##”) where it will insert the code. Be careful how you deal with these existing markers if you modify the IBMLINC.A file.

The output assembly language source file assumes the presence of the UCR Standard Library for 80x86 Assembly Language Programmers. In particular, it needs the STDLIB include files (stdlib.a) and the library file (stdlib.lib).

In Chapter One of this lab manual you should have learned how to set up the Standard Library files on your hard disk. These must be present in the current directory (or in your

INCLUDE/LIB environment paths) or MASM will not be able to properly assemble the output assembly language file. For more information on the UCR Standard Library, see the next chapter.

The following are some IBM/L source files to give you a flavor of the language.

```
; IBM/L Sample program: TESTMUL.IBM.
; This code compares the execution
; time of the MUL instruction vs.
; various shift and add equivalents.

#repetitions 480000
#unravel 1

; The following check checks to see how
; long it takes to multiply two values
; using the IMUL instruction.

#code ("Multiply by 15 using IMUL")
%do
        .286
        mov     cx, 128
        mov     bx, 15
MulLoop1:    mov     ax, cx
            imul  bx
            loop  MulLoop1

#endcode

; Do the same test using the extended IMUL
; instruction on 80286 and later processors.

#code ("Multiplying by 15 using IMUL")
%do
        mov     cx, 128
MulLoop2:    mov     ax, cx
            imul  ax, 15
            loop  MulLoop2

#endcode

; Now multiply by 15 using a shift by four
; bits and a subtract.

#code ("Multiplying by 15 using shifts and sub")
%init
%do
        mov     cx, 128
MulLoop3:    mov     ax, cx
            mov     bx, ax
            shl    ax, 4
            sub    ax, bx
            loop  MulLoop3

#endcode
#end
```

### Output from TESTMUL.IBM:

```
IBM/L 2.0

Public Domain Instruction Benchmarking Language
  by Randall Hyde, inspired by Roedy Green
All times are measured in ticks, accurate only to ±2.

CPU: 80486

Computing Overhead: Multiply by 15 using IMUL
Testing: Multiply by 15 using IMUL
Multiply by 15 using IMUL :370
```

Computing Overhead: Multiplying by 15 using IMUL  
 Testing: Multiplying by 15 using IMUL  
 Multiplying by 15 using IMUL :370  
 Computing Overhead: Multiplying by 15 using shifts and sub  
 Testing: Multiplying by 15 using shifts and sub  
 Multiplying by 15 using shifts and sub :201

```

; IBML Sample program MOVs.
; A comparison of register-register
; moves with register-memory moves

#data
i          word  ?
j          word  ?
k          word  ?
l          word  ?
#enddata

#repetitions 30720000
#unravel 1

; The following check checks to see how
; long it takes to multiply two values
; using the IMUL instruction.

#code ("Register-Register moves, no Hazards")
%do
        mov    bx, ax
        mov    cx, ax
        mov    dx, ax
        mov    si, ax
        mov    di, ax
        mov    bp, ax
#endcode

#code ("Register-Register moves, with Hazards")
%do
        mov    bx, ax
        mov    cx, bx
        mov    dx, cx
        mov    si, dx
        mov    di, si
        mov    bp, di
#endcode

#code ("Memory-Register moves, no Hazards")
%do
        mov    ax, i
        mov    bx, j
        mov    cx, k
        mov    dx, l
        mov    ax, i
        mov    bx, j
#endcode

#code ("Register-Memory moves, no Hazards")
%do
        mov    i, ax
        mov    j, bx
        mov    k, cx
        mov    l, dx
        mov    i, ax
        mov    j, bx
#endcode
#end

```

IBM/L 2.0

Public Domain Instruction Benchmarking Language  
 by Randall Hyde, inspired by Roedy Green  
 All times are measured in ticks, accurate only to 0.2.

CPU: 80486

Computing Overhead: Register-Register moves, no Hazards  
 Testing: Register-Register moves, no Hazards  
 Register-Register moves, no Hazards :25  
 Computing Overhead: Register-Register moves, with Hazards  
 Testing: Register-Register moves, with Hazards  
 Register-Register moves, with Hazards :51  
 Computing Overhead: Memory-Register moves, no Hazards  
 Testing: Memory-Register moves, no Hazards  
 Memory-Register moves, no Hazards :67  
 Computing Overhead: Register-Memory moves, no Hazards  
 Testing: Register-Memory moves, no Hazards  
 Register-Memory moves, no Hazards :387

## 6.17 The CPUDYNO Program

The CPUDYNO program is another program you can use to test the timings of various instructions on your computer. The main purpose of this program is to compute cycle timings for individual instructions and various addressing modes on the CPU you're using. Although your text book publishes Intel/Microsoft instruction timings in the appendices, the published times are often *best case* timings that are difficult to achieve in real programs. Running CPUDYNO allows you to time a set of 80x86 instructions under less than ideal circumstances to get a more realistic instruction execution time.

The timing differences between the Intel published timings and the results CPUDYNO reports are generally due to wait states, prefetch queue loading, cache effects, hazards, instruction prefix bytes, and other timing retardants mentioned only in the fine print in Intel's manuals.

To use CPUDYNO, simply run "CPUDYNO" from the DOS command line. It will display the timings for several 8086 instructions on the screen. You can use I/O redirection to save the output for comparison purposes.

## 6.18 The 80x86 Instruction Set Laboratory Exercises

In this laboratory you will study instruction encodings and timings for several common 8086 instructions. You will use MASM, CodeView, and IBM/L to prepare and test short assembly language programs. You will also learn how to use the linker to combine various object modules and how to set up pathnames for the UCR Standard Library routines. Finally, you will run the CPUDYNO program to test the execution time of various instructions (in cycles) on your computer system (and several different systems, if available).

### 6.18.1 Before Coming to the Laboratory

Your pre-lab report should contain the following:

- A copy of this lab guide chapter with all the questions answered and corrected.
- A write-up on the IBM/L language explaining, in your own words, how the program works.
- A description of what the CPUDYNO program does.

See Chapter Two of this laboratory manual for an example pre-lab report.

Note: your Teaching Assistant or Lab Instructor may elect to give a quiz before the lab begins on the material covered in the laboratory. You will do quite well on that quiz if you've properly prepared for the lab and studied up on the

stuff prior to attending the lab. If you simply copy the material from someone else you will do poorly on the quiz and you will probably not finish the lab. Do not take this pre-lab exercise lightly.





## 6.18.2 Laboratory Exercises

In this laboratory you will perform the following activities:

- Assemble some instructions inside CodeView and inspect their binary encoding.
  - Assemble some short assembly language programs using ML and load the result into CodeView.
  - Observe how several instructions affect the 80x86 flags register.
  - Generate several instruction sequences and compare their relative timings using the IBM/L language.
  - Run the CPUDYNO program and compare the timings it reports against the official Intel timings.
- Exercise 1: Assemble and link the “SHELLASM” file (supplied on the diskette accompanying this lab manual). Be sure that the standard library include and lib files are in the MASM include and lib paths. Assemble SHELLASM using the following command:

```
ml /Zi /Fl shell.asm
```

The “/Zi” option tells ML to specially prepare this file for use with CodeView. It instructs ML to include special information in the .EXE file so CodeView can provide *symbolic source code* debugging facilities. You should use this option whenever you plan to use CodeView to debug your program. You should *not*, however, use this option all the time because it makes the “.EXE” file larger.

The “/Fl” command line item is optional. It instructs ML to create an *assembly listing* of the source file. This listing file includes your source code plus other information including the binary translation of each instruction in the program. (displayed in hexadecimal).

Once you’ve assembled the file (without error), note that ML created *three* new files (assuming they were not present already): SHELL.OBJ, SHELL.EXE, and SHELL.LST. The SHELL.LST file is the one containing the assembly listing. Load this file into your editor or print it out to the printer to see the format of an ML listing file.

**For your lab report:** include the SHELL.LST listing file.

**For additional credit:** Execute the DOS command “ML /?” and have MASM list out all the legal command line options. Explain the purpose of several of these command line options.

- Exercise 2: Load the “LAB5A.ASM” file into the editor and locate the comment which states “Put your main program here.” At this point, insert the following 80x86 assembly language statements:

```
add    ax, bx
sub    ax, bx
and    ax, bx
or     ax, bx
xor    ax, bx

add    bx, ax
add    bx, ds:[0]
add    bx, [bx]
add    bx, 200h[bx]

xor    ax, ax
xor    ax, 1
xor    ax, 100h

xchg   ax, ax
nop

mov    al, 12h
mov    ax, 1234h
```

Assemble this code using the ML command:

```
ml /Zi /Fl lab5a.asm
```

(Note: if the assembler reports an error in the above statements, correct the error in the source file and reissue the ML command.)

**For your lab report:** Edit or print the LAB5A.LST file and look at the binary encodings for each of these instructions. Explain each of the particular values produced by the assembler.

**For additional credit:** look up the instruction encodings for each of these instructions in Appendix D of your textbook. Describe the meaning of each of the hexadecimal values the assembler emits to the object code file.

- Exercise 3: Load the LAB5A.EXE file created by ML above into CodeView using the DOS command:

```
CV LAB5A
```

By default, CodeView will display the file in *source* mode. What you will see in the source window is the text from the LAB5A.ASM file. While this is probably the best mode to use when actually debugging a program (since you see the comments and symbolic names), it will actually interfere with this exercise. To switch from “source” to “assembly” mode, select the “Source Window” item from the “Options” menu. This brings up a dialog box. One of the options in this dialog box is “Display Mode.” Select “Assembly” as the display mode option. You will note that the source display window changes from a nice source display to a disassembly listing. This is fine, the source display hides a lot of important information we want to take a look at.

The first thing you should do is locate the instruction sequence you entered in Exercise 2 above. After finding this sequence, compare the disassembled code against your assembly listing. Report and explain any differences between the assembly listing and the CodeView disassembly.

Note: one difference you will find is the way MASM displays 16-bit (and 32-bit) values in the assembly listing. Normally, MASM displays bytes of object code emitted by the assembler from left to right with the leftmost byte corresponding to the value at the lowest address. For example, MASM typically displays the instruction “MOV AL, 12h” as follows:

```
BO 12          MOV    AL, 12h
```

When MASM encounters a 16 (or 32) bit operand you would expect that it would display the object code bytes from left to right corresponding to L.O. to H.O. However, for such constants MASM swaps the operand bytes so that they read more naturally:

```
B8 1234       MOV    AX, 1234h
```

rather than:

```
B8 34 12      MOV    AX, 1234
```

Note that MASM does *not* put a space between the values when it reverses the byte order. This is how you can tell that it is displaying the bytes in the reverse order. CodeView does not reverse these bytes when it disassembles your code in “assembly” mode.

**For your lab report:** List or otherwise emphasize all instructions in the program that use this display form for 16 bit values.

- Exercise 4: While in CodeView, assemble the following instruction sequences into memory starting at location 8000:0 (using the command window assemble command).

```
mov    al, 0ffh
add    al, 1

mov    al, 7fh
add    al, 1

mov    al, 80h
add    al, 1

mov    al, 0ffh
inc    al

mov    al, 80h
inc    al

int    3
```

Single step through each of the instructions above and note the results in the AL register and the carry, sign, overflow, and zero flags after the execution of each instruction. Comment on the results. (Do not execute the “int 3”

instruction. It's present in case you accidentally execute the "GO" command. It will stop program execution inside CodeView.)

**For your lab report:** Describe the condition code settings (carry, overflow, zero, and sign) after the execution of each instruction and discuss why the 80x86 produces each flag setting.

- Exercise 5: Repeat exercise 4 for the following sequence of compare instructions. Be sure to describe what the flag values mean with respect to the signed and unsigned comparisons being performed.

```

mov     al, 0
cmp     al, 0
cmp     al, 1
cmp     al, 0ffh           ; -1 or +255

mov     al, 1
cmp     al, 0
cmp     al, 1
cmp     al, 2
cmp     al, 0ffh           ; -1 or +255

mov     al, 0ffh
cmp     al, 0feh           ; -2/+254
cmp     al, 0ffh
cmp     al, 0
cmp     al, 1

```

**For your lab report:** Discuss the condition code values after the execution of each of the above CMP instructions.

**For additional credit:** Try some other "boundary" values to when comparing values. Repeat the exercise above.

- Exercise 6: Create an IBM/L program which times the following code sequences. Execute these code sequences to determine which ones are the fastest. If you have access to several different CPUs (e.g., 80286, 80386, 80486) try running the IBM/L output on each of them.. Note: if you are running a machine which emulates the 80x86 using a program such as SoftPC, the timing values you obtain will be meaningless. IBM/L timings are only meaningful when run on a true 80x86 CPU.

For all sequences, place two word variables I and J in the data section. Initialize these variables to five and ten, respectively.

```

; Sequence 1a:

#data
i             word   ?
j             word   ?
#enddata
#unravel 256
#repetitions 250000
#code ("Add one with ADD")
%do
                mov     ax, i
                add     ax, 1
                mov     i, ax
#endcode
#end

Sequence 1b:

#data
i             word   ?
j             word   ?
#enddata
#unravel 256
#repetitions 250000
#code ("Add one with INC")
%do

```

```

                inc    i
#endcode
#end

Sequence 2a:

#data
i                word    ?
j                word    ?
#enddata
#unravel 256
#repetitions 250000
#code ("*4 with MUL")
%do
                mov    al, 4
                mul    i
#endcode
#end

```

```

Sequence 2b:

#data
i                word    ?
j                word    ?
#enddata
#unravel 256
#repetitions 250000
#code ("*4 with SHL")
%do
                mov    ax, i
                shl   ax, 1
                shl   ax, 1
#endcode
#end

```

**For your lab report:** compile the code sequences above using IBM/L and include the results in your lab report.

**For additional credit:** Merge the four sequences above into a single IBM/L program. Create several additional sets of sequences on your own and run these through IBM/L. Use IBM/L to demonstrate the cost of hazards on an 80486 or later processor. Compile and run the sample IBM/L files on the diskette accompanying this lab manual. Explain the results.

- Exercise 7: The IBM/L program is particularly useful to compare the timings of two or more different code fragments that all achieve the same result. Consider the absolute value operation mentioned earlier in this chapter. There were two possible sequences, one that works best for positive values, one that works best for negative values. There are several other ways to implement the absolute value function. The following code sequence achieves this without using any control transfer instructions:

```

                cwd                ;DX becomes 0FFFFh if AX is negative.
                xor    ax, dx      ;Invert AX if it is negative.
                and    dx, 1       ;Convert DX to one (if FFFF) or zero.
                add    ax, dx      ;Add one if AX was negative.

```

The only question is, "which sequence is better?" One way to answer this question is to write a short IBM/L program and try these three segments out. The following code does just that:

```

#repetitions 2000000
#unravel 100

#code ("ABS" Sequence 1 w/positive value")
%discount
                mov    ax, 1       ;Our positive value
%do
                local  ispos       ;This is necessary if you have any
;                                ; labels in the %do section. See

```

## Lab Ch06

```

;                                     ; chapter six for an explanation.

        cmp     ax, 0
        jge    ispos
        neg     ax

ispos:
#endcode

#code   ("ABS" Sequence 2 w/positive value")
%discount
        mov     ax, 1           ;Our positive value
%do
        local  ispos

        neg     ax
        jns    ispos
        neg     ax

ispos:
#endcode

#code   ("ABS" Sequence 3 w/positive value")
%discount
        mov     ax, 1           ;Our positive value
%do
        cwd
        xor     ax, dx
        and     dx, 1
        add     ax, dx

#endcode

#code   ("ABS" Sequence 1 w/negative value")
%discount
        mov     ax, -1          ;Our negative value
%do
        local  ispos

        cmp     ax, 0
        jge    ispos
        neg     ax

ispos:
#endcode

#code   ("ABS" Sequence 2 w/negative value")
%discount
        mov     ax, -1          ;Our negative value
%do
        local  ispos

        neg     ax
        jns    ispos
        neg     ax

ispos:
#endcode

#code   ("ABS" Sequence 3 w/negative value")
%discount
        mov     ax, -1          ;Our negative value
%do
        cwd

```

```

        xor    ax, dx
        and   dx, 1
        add   ax, dx
#endcode
#end

```

**For your lab report:** Describe which instruction sequence is fastest on your machine. Try to explain the results.

**For additional credit:** Try this code on different 80x86 CPUs (if available) and compare the results.

- Exercise 8: Run the sample IBM/L files found on the diskette accompanying this lab manual (LAB8a\_5.IBM, etc.)

**For your lab report:** Explain the results. Describe which instruction sequences are most efficient in each group.

**For additional credit:** Devise your own code sequences and run them under IBM/L to determine which of several code sequences is the fastest.

- Exercise 9: Run the CPUDYNO program on your system.

**For your lab report:** compare the results to the published timings for various 8086 instructions. Discuss what could cause the differences.

**For additional credit:** run CPUDYNO on several different Intel CPUs. Compare their timings against each other and the published results (note: there are several files containing results for various Intel CPUs on the diskette).

- Exercise 10: For this exercise, assemble the "LAB10\_5.ASM" file on the diskette accompanying this lab manual using the command "ml /Fi lab10\_5.asm" to produce an .exe value you can load into CodeView. Connect the circuit you built in the laboratory exercises for Chapter Two to the printer port (LPT1:). Then, following the comments in the code below, single step through this program and observe the results.

```

; LAB10_5.asm
; Sample program that demonstrates the use of the IN & OUT instructions.

dseg                segmentpara public 'data'

; The port variable holds the base address of the LPT1: parallel printer
; port. This is the address of the output port that controls the LEDs
; on the lab circuitry.

Port                word    ?

; InPort is the address of the LPT1: input port. You can read the switches
; on the lab circuitry from this port.

InPort              word    ?

dseg                ends

cseg                segmentpara public 'code'
                    assume cs:cseg, ds:dseg

Main                proc
                    mov     ax, dseg
                    mov     ds, ax

; The base address of the LPT1: port is stored at address 40:8 in memory.
; Fetch that value and initialize our Port and InPort variables with that
; value. (Note: if you want to use LPT2: or LPT3: rather than LPT1:, their
; base addresses appear at locations 40:A and 40:C, respectively.)

                    mov     ax, 40h           ;Point ES at the BIOS data segment.
                    mov     es, ax

; Change the following value from 8 to 0ah or 0ch for LPT2: or LPT3:

```

```

        mov     ax, es:[8];Fetch base address of LPT1: port.
        mov     Port, ax
        inc     ax           ;Point at input port.
        mov     InPort, ax

; The switches on your lab circuitry come in on bits 3, 4, 5, and 6 of
; the input port.  These bits contain a one if the switch is in the *OFF*
; position.  They contain a zero if the switch is in the *ON* position.
; Intuitively, this is backwards.  Be aware of this.
;
; Using CodeView, single step through the following instructions.
; After the execution of each IN instruction, change the switch settings
; on your circuitry and observe the value read into AL with the execution
; of each successive IN statement.

        mov     dx, InPort
        in     al, dx
        in     al, dx
        in     al, dx
        in     al, dx
        in     al, dx
        in     al, dx
        in     al, dx
        in     al, dx

; The LEDs on your lab circuitry are connected to bits zero through eight
; of the output port (Port).  Writing a one to a particular bit turns that
; LED *ON*.  Writing a zero to a particular bit turns that LED off.  Note
; that address "Port" is an I/O address.  You can read and write the data
; at that address (reading this port reads the last value written to it).
; The following code reads the switches, inverts their values, and then
; initializes LEDs zero through three with these switch values.  The code
; then rotates these bit settings through the LEDs several times.  Use
; CodeView to single step through these instructions.

        in     al, dx           ;DX still contains InPort's value.
        mov     cl, 3           ;Move the switches down to bit 0.
        shr     al, cl
        and     al, 0Fh         ;Mask out the other bits.
        xor     al, 0Fh         ;Invert switch readings.

        mov     dx, Port;Point DX out the output port.
        out    dx, al           ;Write switch settings to the LEDs.

        in     al, dx           ;Read previous value.
        rol     al, 1           ;Rotate bits.
        out    dx, al           ;Write back to LEDs.

        in     al, dx
        rol     al, 1
        out    dx, al

        in     al, dx
        rol     al, 1
        out    dx, al

        in     al, dx
        rol     al, 1
        out    dx, al

        in     al, dx
        rol     al, 1
        out    dx, al

```

## Lab Ch06

```

        in     al, dx
        rol   al, 1
        out   dx, al

        in     al, dx
        rol   al, 1
        out   dx, al

Quit:   mov    ah, 4ch           ;DOS opcode to quit program.
        int   21h             ;Call DOS.
Main    endp
cseg    ends

sseg    segmentpara stack 'stack'
stk     byte  1024 dup ("stack ")
sseg    ends

zzzzzzseg segmentpara public 'zzzzzz'
LastBytes byte  16 dup (?)
zzzzzzseg ends
end     Main
```

**For your lab report:** Describe what happens to AX, DX and the LEDs after the execution of each instruction above.



---

## 6.19 Sample Programs

Most real programs only use a small subset of the entire 80x86 instruction set. Therefore you do not have to learn the complete operation and usage of *every* 80x86 instruction in order to write typical assembly language programs. However, if you are comfortable with the entire instruction set, you will probably write better assembly language programs because you'll often use an appropriate instruction sequence rather than synthesize the operation with a longer sequence of instructions.

This section presents several short sample programs that demonstrate the use of several 80x86 assembly language instructions. It shows the syntax of many instructions and how one would typically use them.

---

### 6.19.1 Sample Program #1: Simple Arithmetic

This program demonstrates how to use the 80x86 add, sub, neg, inc, and dec instructions to perform simple calculations.

```

; Simple Arithmetic
; This program demonstrates some simple arithmetic instructions.

                .386
                option     segment:use16

dseg           segment   para public 'data'

; Some type definitions for the variables we will declare:

uint           typedef   word           ;Unsigned integers.
integer        typedef   sword          ;Signed integers.

; Some variables we can use:

j              integer   ?
k              integer   ?
l              integer   ?

u1            uint      ?
u2            uint      ?
u3            uint      ?

dseg          ends

cseg          segment   para public 'code'
                assume   cs:cseg, ds:dseg

Main          proc
                mov      ax, dseg
                mov      ds, ax
                mov      es, ax

; Initialize our variables:

                mov      j, 3
                mov      k, -2

                mov      u1, 254
                mov      u2, 22

; Compute L := j+k and u3 := u1+u2

```

## Lab Ch06

```

        mov     ax, J
        add     ax, K
        mov     L, ax

        mov     ax, u1           ;Note that we use the "ADD"
        add     ax, u2           ; instruction for both signed
        mov     u3, ax          ; and unsigned arithmetic.

; Compute L := j-k and u3 := u1-u2

        mov     ax, J
        sub     ax, K
        mov     L, ax

        mov     ax, u1           ;Note that we use the "SUB"
        sub     ax, u2           ; instruction for both signed
        mov     u3, ax          ; and unsigned arithmetic.

; Compute L := -L

        neg     L

; Compute L := -J

        mov     ax, J           ;Of course, you would only use the
        neg     ax              ; NEG instruction on signed values.
        mov     L, ax

; Compute K := K + 1 using the INC instruction.

        inc     K

; Compute u2 := u2 + 1 using the INC instruction.
; Note that you can use INC for signed and unsigned values.

        inc     u2

; Compute J := J - 1 using the DEC instruction.

        dec     J

; Compute u2 := u2 - 1 using the DEC instruction.
; Note that you can use DEC for signed and unsigned values.

        dec     u2

Quit:   mov     ah, 4ch           ;DOS opcode to quit program.
        int     21h             ;Call DOS.
Main    endp

cseg    ends

sseg    segment    para stack 'stack'
stk     byte      1024 dup ("stack ")
sseg    ends

zzzzzzseg segment    para public 'zzzzzz'
LastBytes byte      16 dup (?)
zzzzzzseg ends
end     Main

```

## 6.19.2 Sample Program #2: Multiplication and Division

Unfortunately, multiplication and division work a little differently on the 80x86 than the other arithmetic instructions like add and subtract. This section demonstrates the use of the `mul`, `imul`, `div`, and `idiv` instructions in an assembly language program. Don't forget that the division operation can crash your program if you attempt to divide by zero or if the operands are otherwise out of range.

```

; Simple Arithmetic: multiplication and division
; This program demonstrates some simple arithmetic instructions.

                .386                ;So we can use extended registers
                option             segment:use16    ; and addressing modes.

dseg           segment    para public 'data'

; Some type definitions for the variables we will declare:

uint           typedef     word           ;Unsigned integers.
integer        typedef     sword         ;Signed integers.

; Some variables we can use:

j              integer     ?
k              integer     ?
l              integer     ?

u1             uint        ?
u2             uint        ?
u3             uint        ?

dseg           ends

cseg           segment     para public 'code'
                assume     cs:cseg, ds:dseg

Main           proc
                mov        ax, dseg
                mov        ds, ax
                mov        es, ax

; Initialize our variables:

                mov        j, 3
                mov        k, -2

                mov        u1, 254
                mov        u2, 22

; Extended multiplication using 8086 instructions.
;
; Note that there are separate multiply instructions for signed and
; unsigned operands.
;
; L := J * K (ignoring overflow)

                mov        ax, J
                imul       K           ;Computes DX:AX := AX * K
                mov        L, ax       ;Ignore overflow into DX.

```

## Lab Ch06

```

; u3 := u1 * u2

        mov     ax, u1
        mul     u2           ;Computes DX:AX := AX * U2
        mov     u3, ax      ;Ignore overflow in DX.

; Extended division using 8086 instructions.
;
; Like multiplication, there are separate instructions for signed
; and unsigned operands.
;
; It is absolutely imperative that these instruction sequences sign
; extend or zero extend their operands to 32 bits before dividing.
; Failure to do so will may produce a divide error and crash the
; program.
;
; L := J div K

        mov     ax, J
        cwd                     ;*MUST* sign extend AX to DX:AX!
        idiv    K               ;AX := DX:AX/K, DX := DX:AX mod K
        mov     L, ax

; u3 := u1/u2

        mov     ax, u1
        mov     dx, 0           ;Must zero extend AX to DX:AX!
        div     u2              ;AX := DX:AX/u2, DX := DX:AX mod u2
        mov     u3, ax

; Special forms of the IMUL instruction available on 80286, 80386, and
; later processors. Technically, these instructions operate on signed
; operands only, however, they do work fine for unsigned operands as well.
; Note that these instructions produce a 16-bit result and set the overflow
; flag if overflow occurs.
;
; L := J * 10 (80286 and later only)

        imul    ax, J, 10       ;AX := J*10
        mov     L, ax

; L := J * K (80386 and later only)

        mov     ax, J
        imul    ax, K
        mov     L, ax

Quit:    mov     ah, 4ch         ;DOS opcode to quit program.
        int     21h           ;Call DOS.
Main     endp

cseg     ends

sseg     segment para stack 'stack'
stk      byte   1024 dup ("stack ")
sseg     ends

zzzzzzseg segment para public 'zzzzzz'
LastBytes byte 16 dup (?)
zzzzzzseg ends

```

```
end Main
```

---

### 6.19.3 Sample Program #3: Logical Operations

The following short assembly language program demonstrates the use of the and, or, xor, and not instructions.

```
; Logical Operations
; This program demonstrates the AND, OR, XOR, and NOT instructions

        .386                ;So we can use extended registers
        option             segment:use16    ; and addressing modes.

dseg    segment      para public 'data'

; Some variables we can use:

j        word       0FF00h
k        word       0FFF0h
l        word       ?

c1       byte       'A'
c2       byte       'a'

LowerMask byte       20h

dseg     ends

cseg     segment     para public 'code'
        assume      cs:cseg, ds:dseg

Main     proc
        mov         ax, dseg
        mov         ds, ax
        mov         es, ax

; Compute L := J and K (bitwise AND operation):

        mov         ax, J
        and         ax, K
        mov         L, ax

; Compute L := J or K (bitwise OR operation):

        mov         ax, J
        or          ax, K
        mov         L, ax

; Compute L := J xor K (bitwise XOR operation):

        mov         ax, J
        xor         ax, K
        mov         L, ax

; Compute L := not L (bitwise NOT operation):

        not        L
```

```

; Compute L := not J (bitwise NOT operation):

        mov     ax, J
        not     ax
        mov     L, ax

; Clear bits 0..3 in J:

        and     J, 0FFF0h

; Set bits 0..3 in K:

        or      K, 0Fh

; Invert bits 4..11 in L:

        xor     L, 0FF0h

; Convert the character in C1 to lower case:

        mov     al, c1
        or      al, LowerMask
        mov     c1, al

; Convert the character in C2 to upper case:

        mov     al, c2
        and     al, 5Fh           ;Clears bit 5.
        mov     c2, al

Quit:   mov     ah, 4ch           ;DOS opcode to quit program.
        int     21h           ;Call DOS.
Main    endp

cseg    ends

sseg    segment para stack 'stack'
stk     byte   1024 dup ("stack ")
sseg    ends

zzzzzzseg segment para public 'zzzzzz'
LastBytes byte 16 dup (?)
zzzzzzseg ends
end     Main

```

---

#### 6.19.4 Sample Program #4: Shift and Rotate Instructions

The following sample program shows how to use some of the 80x86's shift and rotate instructions. It also demonstrates how to pack data using these instructions.

```

; Shift and Rotate Instructions

        .386                       ;So we can use extended registers
        option segment:use16       ; and addressing modes.

dseg    segment para public 'data'

```

## Lab Ch06

; The following structure holds the bit values for an 80x86 mod-reg-r/m byte.

```
mode          struct
modbits       byte    ?
reg           byte    ?
rm            byte    ?
mode          ends

Adrs1         mode    {11b, 100b, 111b}
modregrm     byte    ?

var1          word    1
var2          word    8000h
var3          word    0FFFFh
var4          word    ?

dseg          ends

cseg          segment para public 'code'
              assume  cs:cseg, ds:dseg

Main          proc
              mov     ax, dseg
              mov     ds, ax
              mov     es, ax

; Shifts and rotates directly on memory locations:
;
; var1 := var1 shl 1
              shl     var1, 1

; var1 := var1 shr 1
              shr     var1, 1

; On 80286 and later processors, you can shift by more than one bit at
; at time:
              shl     var1, 4
              shr     var1, 4

; The arithmetic shift right instruction retains the H.O. bit after each
; shift. The following SAR instruction sets var2 to 0FFFFh
              sar     var2, 15

; On all processors, you can specify a shift count in the CL register.
; The following instruction restores var2 to 8000h:
              mov     cl, 15
              shl     var2, cl

; You can use the shift and rotate instructions, along with the logical
; instructions, to pack and unpack data. For example, the following
; instruction sequence extracts bits 10..13 of var3 and leaves
; this value in var4:
              mov     ax, var3
              shr     ax, 10           ;Move bits 10..13 to 0..3.
              and     ax, 0Fh        ;Keep only bits 0..3.
              mov     var4, ax

; You can use the rotate instructions to compute this value somewhat faster
```

```
; on older processors like the 80286.
```

```
    mov     ax, var3
    rol     ax, 6           ;Six rotates rather than 10 shifts.
    and     ax, 0Fh
    mov     var4, ax
```

```
; You can use the shift and OR instructions to easily merge separate fields
; into a single value. For example, the following code merges the mod, reg,
; and r/m fields (maintained in separate bytes) into a single mod-reg-r/m
; byte:
```

```
    mov     al, Adrs1.modbits
    shl     al, 3
    or      al, Adrs1.reg
    shl     al, 3
    or      al, Adrs1.rm
    mov     modregrm, al
```

```
; If you've only got and 8086 or 8088 chip, you'd have to use code like the
; following:
```

```
    mov     al, Adrs1.modbits ;Get mod field
    shl     al, 1
    shl     al, 1
    or      al, Adrs1.reg     ;Get reg field
    mov     cl, 3
    shl     al, cl           ;Make room for r/m field.
    or      al, Adrs1.rm     ;Merge in r/m field.
    mov     modregrm, al     ;Save result away.
```

```
Quit:    mov     ah, 4ch       ;DOS opcode to quit program.
         int     21h         ;Call DOS.
```

```
Main     endp
```

```
cseg     ends
```

```
sseg     segment para stack 'stack'
stk      byte   1024 dup ("stack  ")
sseg     ends
```

```
zzzzzzseg segment para public 'zzzzzz'
LastBytes byte   16 dup (?)
zzzzzzseg ends
end      Main
```

### 6.19.5 Sample Program #5: Bit Operations and the SETcc Instruction

The following program shows how to test to see if certain bits are set or clear. It also demonstrates the use of the setcc instructions to set a boolean variable true or false depending upon some condition.

```
; Bit Operations and SETcc Instructions
```

```
    .386                               ;So we can use extended registers
    option segment:use16               ; and addressing modes.
```

```
dseg     segment para public 'data'
```



## Lab Ch06

```
; Some type definitions for the variables we will declare:

uint      typedef   word           ;Unsigned integers.
integer   typedef   sword          ;Signed integers.

; Some variables we can use:

j         integer   ?
k         integer   ?
u1        uint     2
u2        uint     2
Result    byte     ?

dseg      ends

cseg      segment   para public 'code'
          assume    cs:cseg, ds:dseg

Main      proc
          mov       ax, dseg
          mov       ds, ax
          mov       es, ax

; Initialize some variables

          mov       j, -2
          mov       k, 2

; The SETcc instructions store a one or zero into their operand if the
; specified condition is true or false, respectively. The TEST instruction
; logically ANDs its operands and sets the flags accordingly (in particular,
; TEST sets/clears the zero flag if there is/isn't a zero result). We can
; use these two facts to copy a single bit (zero extended) to a byte operand.

          test      j, 11000b        ;Test bits 4 and 5.
          setne    Result            ;Result=1 if bits 4 or 5 of J are 1.

          test      k, 10b          ;Test bit #1.
          sete     Result            ;Result=1 if bit #1 = 0.

; The SETcc instructions are particularly useful after a CMP instruction.
; You can set a boolean value according to the result of the comparison.
;
; Result := j <= k

          mov       ax, j
          cmp       ax, k
          setle    Result            ;Note that "setle" is for signed values.

; Result := u1 <= u2

          mov       ax, u1
          cmp       ax, u2
          setbe    Result            ;Note that "setbe" is for unsigned values.

; One thing nice about the boolean results that the SETcc instructions
; produce is that we can AND, OR, and XOR them and get the same results
; one would expect in a HLL like C, Pascal, or BASIC.
;
; Result := (j < k) and (u1 > u2)
```

## Lab Ch06

```

        mov     ax, j
        cmp     ax, k
        setl   bl                ;Use "setl" for signed comparisons.

        mov     ax, u1
        cmp     ax, u2
        seta   al                ;Use "seta" for unsigned comparisons.

        and     al, bl           ;Logically AND the two boolean results
        mov     Result, al      ; and store the result away.

; Sometimes you can use the shift and rotate instructions to test to see
; if a specific bit is set. For example, SHR copies bit #0 into the carry
; flag and SHL copies the H.O. bit into the carry flag. We can easily test
; these bits as follows:
;
; Result := bit #15 of J.

        mov     ax, j
        shl     ax, 1
        setc   Result

; Result := bit #0 of u1:

        mov     ax, u1
        shr     ax, 1
        setc   Result

; If you don't have an 80386 or later processor and cannot use the SETcc
; instructions, you can often simulate them. Consider the above two
; sequences rewritten for the 8086:

;
; Result := bit #15 of J.

        mov     ax, j
        rol     ax, 1           ;Copy bit #15 to bit #0.
        and     al, 1          ;Strip other bits.
        mov     Result, al

; Result := bit #0 of u1:

        mov     ax, u1
        and     al, 1          ;Strip unnecessary bits.
        mov     Result, al

Quit:   mov     ah, 4ch         ;DOS opcode to quit program.
        int     21h          ;Call DOS.
Main    endp

cseg    ends

sseg    segment   para stack 'stack'
stk     byte     1024 dup ("stack  ")
sseg    ends

zzzzzzseg segment   para public 'zzzzzz'
LastBytes byte    16 dup (?)
zzzzzzseg ends
end     Main

```

## 6.19.6 Sample Program #6: String Instructions

This program demonstrates simple uses of some string instructions. It shows how you can easily manipulate array elements using these instructions.

```

; String Instructions

                .386                ;So we can use extended registers
                option               ; and addressing modes.
                segment:use16

dseg            segment      para public 'data'

String1        byte        "String",0
String2        byte        7 dup (?)

Array1         word        1, 2, 3, 4, 5, 6, 7, 8
Array2         word        8 dup (?)

dseg            ends

cseg            segment      para public 'code'
                assume      cs:cseg, ds:dseg

Main           proc
                mov         ax, dseg
                mov         ds, ax
                mov         es, ax

; The string instructions let you easily copy data from one array to
; another.  If the direction flag is clear, the movsb instruction
; does the equivalent of the following:
;
;     mov es:[di], ds:[si]
;     inc  si
;     inc  di
;
; The following code copies the seven bytes from String1 to String2:

                cld                ;Required if you want to INC SI/DI

                lea        si, String1
                lea        di, String2

                movsb                ;String2[0] := String1[0]
                movsb                ;String2[1] := String1[1]
                movsb                ;String2[2] := String1[2]
                movsb                ;String2[3] := String1[3]
                movsb                ;String2[4] := String1[4]
                movsb                ;String2[5] := String1[5]
                movsb                ;String2[6] := String1[6]

; The following code sequence demonstrates how you can use the LODSW and
; STOWS instructions to manipulate array elements during the transfer.
; The following code computes
;
;     Array2[0] := Array1[0]
;     Array2[1] := Array1[0] * Array1[1]
;     Array2[2] := Array1[0] * Array1[1] * Array1[2]
;     etc.
;

```

## Lab Ch06

; Of course, it would be far more efficient to put the following code  
; into a loop, but that will come later.

```
        lea    si, Array1
        lea    di, Array2

        lodsw
        mov    dx, ax
        stosw

        lodsw
        imul  ax, dx
        mov    dx, ax
        stosw

        lodsw
        imul  ax, dx
        mov    dx, ax
        stosw

        lodsw
        imul  ax, dx
        mov    dx, ax
        stosw

        lodsw
        imul  ax, dx
        mov    dx, ax
        stosw

        lodsw
        imul  ax, dx
        mov    dx, ax
        stosw

        lodsw
        imul  ax, dx
        mov    dx, ax
        stosw

Quit:   mov    ah, 4ch          ;DOS opcode to quit program.
        int    21h          ;Call DOS.
Main    endp

cseg    ends

sseg    segment    para stack 'stack'
stk     byte    1024 dup ("stack  ")
sseg    ends

zzzzzzseg segment    para public 'zzzzzz'
LastBytes byte    16 dup (?)
zzzzzzseg ends
end     Main
```

---

## 6.19.7 Sample Program #7: Unconditional JMP Instructions

This program demonstrates various forms of the unconditional jump instruction. To fully appreciate the differences, you will need to look at the object code produced by this program. You can do this by assembling the program and producing an assembly listing. The MASM command to do this is<sup>6</sup>

```
ml /Fl ex7_5.asm
```

This produces a file named “ex7\_5.lst” that contains the assembled listing. The assembly listing contains the offsets and opcodes for each instruction. By studying these opcodes you can see the differences between these instructions. See Appendix D for details on jmp instruction encoding.

```

; Unconditional Jumps

        .386
        option      segment:use16

dseg    segment      para public 'data'

; Pointers to statements in the code segment

IndPtr1    word      IndTarget2
IndPtr2    dword     IndTarget3

dseg      ends

cseg      segment    para public 'code'
           assume    cs:cseg, ds:dseg

Main      proc
           mov       ax, dseg
           mov       ds, ax
           mov       es, ax

; JMP instructions transfer control to the
; location specified in the operand field.
; This is typically a label that appears
; in the program.
;
; There are many variants of the JMP
; instruction. The first is a two-byte
; opcode that transfers control to +/-128
; bytes around the current instruction:

           jmp       CloseLoc
           nop

CloseLoc:

; The next form is a three-byte instruction
; that allows you to jump anywhere within
; the current code segment. Normally, the
; assembler would pick the shortest version
; of a given JMP instruction, the "near ptr"

```

---

6. The file for this program, ex7\_5.asm, is on the diskette accompanying this laboratory manual.

## Lab Ch06

```
; operand on the following instruction
; forces a near (three byte) JMP:
```

```
        jmp     near ptr NearLoc
        nop
```

NearLoc:

```
; The third form to consider is a five-byte
; instruction that provides a full segmented
; address operand. This form of the JMP
; instruction lets you transfer control any-
; where in the program, even to another
; segment. The "far ptr" operand forces
; this form of the JMP instruction:
```

```
        jmp     far ptr FarLoc
        nop
```

FarLoc:

```
; You can also load the target address of a
; near JMP into a register and jump indirectly
; to the target location. Note that you can
; use any 80x86 general purpose register to
; hold this address; you are not limited to
; the BX, SI, DI, or BP registers.
```

```
        lea     dx, IndTarget
        jmp     dx
        nop
```

IndTarget:

```
; You can even jump indirect through a memory
; variable. That is, you can jump through a
; pointer variable directly without having to
; first load the pointer variable into a reg-
; ister (Chapter Six describes why the following
; labels need two colons).
```

```
        jmp     IndPtr1
        nop
```

IndTarget2::

```
; You can even execute a far jump indirect
; through memory. Just specify a dword
; variable in the operand field of a JMP
; instruction:
```

```
        jmp     IndPtr2
        nop
```

IndTarget3::

```
Quit:      mov     ah, 4ch
           int     21h
Main       endp
cseg      ends
```

```

sseg      segment    para stack 'stack'
stk       byte      1024 dup ("stack  ")
sseg      ends

zzzzzzseg segment    para public 'zzzzzz'
LastBytes byte      16 dup (?)
zzzzzzseg ends
end       Main

```

## 6.19.8 Sample Program #8: CALL and Interrupt Instructions

This program demonstrates various forms of the `call`, `ret`, and `int` instructions. Like the previous program, you will need to look at the object code and Appendix D to truly appreciate the differences in these instructions. To produce an assembly listing, use the following command on the `ex8_5.asm` file:

```
ml /Fl ex8_5.asm
```

This produces the file “`ex8_5.lst`” that contains a listing of the bytes each instruction emits.

Chapter Six discusses the use of the `proc` and `endp` statements. This program uses them to create near and far procedures that this code can invoke using the `call` instruction.

```

; CALL and INT Instructions

                .386
                option    segment:use16

dseg          segment    para public 'data'

; Some pointers to our subroutines:

SPtr1        word      Subroutine1
SPtr2        dword     Subroutine2

dseg          ends

cseg          segment    para public 'code'
                assume   cs:cseg, ds:dseg

Subroutine1   proc      near
                ret
Subroutine1   endp

Subroutine2   proc      far
                ret
Subroutine2   endp

Main         proc
                mov     ax, dseg
                mov     ds, ax
                mov     es, ax

; Near call:

                call    Subroutine1

; Far call:

```

```

        call     Subroutine2

; Near register-indirect call:

        lea     cx, Subroutine1
        call    cx

; Near memory-indirect call:

        call    SPtr1

; Far memory-indirect call:

        call    SPtr2

; INT transfers control to a routine whose
; address appears in the interrupt vector
; table (see Chapter 15 for details on
; the interrupt vector table). The following
; call tells the PC's BIOS to print the
; ASCII character in AL to the display.

        mov     ah, 0eh
        mov     al, 'A'
        int     10h

; INTO generates an INT 4 if the 80x86
; overflow flag is set. It becomes a
; NOP if the overflow flag is clear.
; You can use this instruction after
; an arithmetic operation to quickly
; test for a fatal overflow. Note:
; the following sequence does *not*
; generate an overflow. Do not modify
; it so that it does unless you add an
; INT 4 interrupt service routine to
; the interrupt vector table (see Chapter
; 15 for details)

        mov     ax, 2
        add     ax, 4
        into

Quit:    mov     ah, 4ch
        int     21h

Main    endp
cseg    ends

sseg    segment    para stack 'stack'
stk     byte      1024 dup ("stack ")
sseg    ends

zzzzzzseg    segment    para public 'zzzzzz'
LastBytes   byte      16 dup (?)
zzzzzzseg    ends
end        Main

```



## 6.19.9 Sample Program #9: Conditional Jump Instructions

The conditional jump instructions are some of the most important instructions in the 80x86 instruction set. An assembly language programmer uses these instructions to make decisions and create loops in a program. The following program demonstrates some of the capabilities of these instructions.

On the 80286 and earlier processors, the conditional instructions only allow you to branch to an instruction  $\pm 128$  bytes around the current instruction. With MASM 5.1 and earlier, you had to manually convert out of range branches. MASM 6.x and later will do this for you automatically. The 80386 and later processor provide special forms of the conditional jump instructions that allow you to jump anywhere within the current code segment. If you specify the use of an 80386 or later processor, MASM will automatically use this form of the instruction if the shorter form is out of range. The following program demonstrates how MASM 6.x automatically extends out of range jumps. Once again, you will need to produce an assembly listing to see the actual opcodes MASM emits. To do this, use the DOS command:

```
ml /Fl ex9_5.asm
```

This produces the file "ex9\_5.lst" that contains the assembly listing.

Do not run this program. It's only purpose is to demonstrate how MASM emits opcodes for various conditional jump instructions. It may hang the machine if you attempt to run it from DOS.

```
; Conditional JMP Instructions, Part I

                .386
                option      segment:use16
dseg            segment    para public 'data'
J               sword     ?
K               sword     ?
L               sword     ?
dseg            ends

cseg            segment    para public 'code'
                assume     cs:cseg, ds:dseg

Main            proc
                mov         ax, dseg
                mov         ds, ax
                mov         es, ax

; 8086 conditional jumps are limited to
; +/- 128 bytes because they are only
; two bytes long (one byte opcode, one
; byte displacement).

                .8086
                ja          lbl
                nop
lbl:

; MASM 6.x will automatically extend out of
; range jumps. The following are both
; equivalent:

                ja          lbl2
                byte        150 dup (0)      ;Make target greater than 128 bytes away.
lbl2:
```

## Lab Ch06

```

                jna     Temp
                jmp     lbl3
Temp:
                byte   150 dup (0)      ;Make target greater than 128 bytes away.
lbl3:

; The 80386 and later processors support a
; special form of the conditional jump
; instructions that allow a two-byte displace-
; ment, so MASM 6.x will assemble the code
; to use this form if you've specified an
; 80386 processor.

                .386
                ja     lbl4
                byte   150 dup (0)      ;Make target more than 128 bytes away.
lbl4:

; The conditional jump instructions work
; well with the CMP instruction to let you
; execute certain instruction sequences
; only if a condition is true or false.
;
; if (J <= K) then
;     L := L + 1
; else L := L - 1

                mov     ax, J
                cmp     ax, K
                jnle    DoElse
                inc     L
                jmp     ifDone

DoElse:        dec     L
ifDone:

; You can also use a conditional jump to
; create a loop in an assembly language
; program:
;
; while (j >= k) do begin
;
;     j := j - 1;
;     k := k + 1;
;     L := j * k;
; end;

WhlLoop:      mov     ax, j
                cmp     ax, k
                jnge    QuitLoop

                dec     j
                inc     k
                mov     ax, j
                imul   ax, k
                mov     L, ax
                jmp     WhlLoop

QuitLoop:

Quit:         mov     ah, 4ch           ;DOS opcode to quit program.

```

```

        int      21h          ;Call DOS.
Main    endp
cseg    ends

sseg    segment   para stack 'stack'
stk     byte     1024 dup ("stack ")
sseg    ends

zzzzzzseg segment   para public 'zzzzzz'
LastBytes byte     16 dup (?)
zzzzzzseg ends
end     Main

```

---

### 6.19.10 Sample Program #10: More Conditional Jump Instructions

This short sample program demonstrates how to use the loop and loopne instructions to create simple loops within your programs. It also demonstrates how to use the conditional jump instructions to simulate the operation of the setcc instructions on 80286 and earlier processors.

```

; Conditional JMP Instructions, Part II

        .386
        option   segment:usel6
dseg    segment   para public 'data'

Array1  word     1, 2, 3, 4, 5, 6, 7, 8
Array2  word     8 dup (?)

String1 byte     "This string contains lower case characters",0
String2 byte     128 dup (0)

j       sword    5
k       sword    6

Result  byte     ?

dseg    ends

cseg    segment   para public 'code'
        assume   cs:cseg, ds:dseg

Main    proc
        mov     ax, dseg
        mov     ds, ax
        mov     es, ax

; You can use the LOOP instruction to repeat a sequence of statements
; some specified number of times in an assembly language program.
; Consider the code taken from EX6_5.ASM that used the string
; instructions to produce a running product:
;
; The following code uses a loop instruction to compute:
;
;   Array2[0] := Array1[0]
;   Array2[1] := Array1[0] * Array1[1]
;   Array2[2] := Array1[0] * Array1[1] * Array1[2]
;   etc.

        cld

```

Lab Ch06

```

        lea    si, Array1
        lea    di, Array2
        mov    dx, 1           ;Initialize for 1st time.
        mov    cx, 8           ;Eight elements in the arrays.

LoopHere: lodsw
          imul  ax, dx
          mov   dx, ax
          stosw
          loop  LoopHere

```

; The LOOPNE instruction is quite useful for controlling loops that  
 ; stop on some condition or when the loop exceeds some number of  
 ; iterations. For example, suppose string1 contains a sequence of  
 ; characters that end with a byte containing zero. If you wanted to  
 ; convert those characters to upper case and copy them to string2,  
 ; you could use the following code. Note how this code ensures that  
 ; it does not copy more than 127 characters from string1 to string2  
 ; since string2 only has enough storage for 127 characters (plus a  
 ; zero terminating byte).

```

          lea    si, String1
          lea    di, String2
          mov    cx, 127       ;Max 127 chars to string2.

CopyStrLoop: lodsb           ;Get char from string1.
              cmp    al, 'a'   ;See if lower case
              jb     NotLower  ;Characters are unsigned.
              cmp    al, 'z'
              ja     NotLower
              and    al, 5Fh    ;Convert lower->upper case.

NotLower:   stosb
              cmp    al, 0      ;See if zero terminator.
              loopne CopyStrLoop ;Quit if al or cx = 0.

```

; If you do not have an 80386 (or later) CPU and you would like the  
 ; functionality of the SETcc instructions, you can easily achieve  
 ; the same results using code like the following:  
 ;  
 ; Result := J <= K;

```

          mov    Result, 0      ;Assume false.
          mov    ax, J
          cmp    ax, K
          jnle   Skip1
          mov    Result, 1      ;Set to 1 if J <= K.

Skip1:

```

; Result := J = K;

```

          mov    Result, 0      ;Assume false.
          mov    ax, J
          cmp    ax, K
          jne    Skip2
          mov    Result, 1

Skip2:

```

## Lab Ch06

```
Quit:      mov      ah, 4ch      ;DOS opcode to quit program.
           int      21h        ;Call DOS.
Main
           endp

cseg      ends

sseg      segment para stack 'stack'
stk       byte     1024 dup ("stack ")
sseg      ends

zzzzzzseg segment para public 'zzzzzz'
LastBytes byte     16 dup (?)
zzzzzzseg ends
end       Main
```

## 6.20 Programming Projects

- ❑ Program #1: Write a short “GetLine” routine which reads up to 80 characters from the user and places these characters in successive locations in a buffer in your data segment. Use the INT 16h and INT 10h system BIOS calls described in this chapter to input and output the characters typed by the user. Terminate input upon encountering a carriage return (ASCII code 0Dh) or after the user types the 80<sup>th</sup> character. Be sure to count the number of characters actually typed by the user for later use. There is a “shell” program specifically designed for this project on the diskette accompanying this manual (proj1\_5.asm).
- ❑ Program #2: Modify the above routine so that it properly handles the backspace character (ASCII code 08h). Whenever the user presses a backspace key, you should remove the previous keystroke from the input buffer (unless there are no previous characters in the input buffer, in which case you ignore the backspace).
- ❑ Program #3: You can use the XOR operation to *encrypt* and *decrypt* data. If you XOR all the characters in a message with some value you will effectively *scramble* that message. You can retrieve the original message by XOR'ing the characters in the message with the same value again. Modify the code in Program #2 so that it encrypts each byte in the message with the value 0Fh and displays the encrypted message to the screen. After displaying the message, decrypt it by XOR'ing with 0Fh again and display the decrypted message. Note that you should use the count value computed by the “GetLine” code to determine how many characters to process.
- ❑ Program #4: Write a “PutString” routine that prints the characters pointed at by the es:di register pair. This routine should print all characters up to (but not including) a zero terminating byte. This routine should preserve all registers it modifies. There is a “shell” program specifically designed for this project on the diskette accompanying this manual (proj4\_5.asm).
- ❑ Program #5: To output a 16-bit integer value as the corresponding string of decimal digits, you can use the following algorithm:

```

if value = 0 then write('0')
else begin

    DivVal := 10000;
    while (Value mod DivVal) = 0 do begin

        Value := Value mod DivVal;
        DivVal := DivVal div 10;

    end;

    while (DivVal > 1) do begin

        write ( chr( Value div DivVal + 48 )); (* 48 = '0' *)
        Value := Value mod DivVal;
        DivVal := DivVal div 10;

    end;
end;

```

Provide a short routine that takes an arbitrary value in ax and outputs it as the corresponding decimal string. Use the int 10h instruction to output the characters to the display. You can use the “shell” program provided on the diskette to begin this project (proj5\_5.asm).

- ❑ Program #6: To input a 16-bit integer from the keyboard, you need to use code that uses the following algorithm:

```

Value := 0
repeat

    getchar(ch);
    if (ch >= '0') and (ch <= '9') then begin

```

```

        Value := Value * 10 + ord(ch) - ord('0');
    end;
until (ch < '0') or (ch > '9');

```

Use the INT 16h instruction (described in this chapter) to read characters from the keyboard. Use the output routine in program #4 to display the input result. You can use the “shell” file proj6\_5.asm to start this project.

- Program #7: Write a program that reads the switches from your circuitry from this lab. It should read the switches on the input port and write the switch values to four separate byte variables: sw1, sw2, sw3, and sw4. The variables should contain a one if the switch is in the on position, they should contain a zero if the switch is in the off position. Next, write a short routine that merges bit #0 in the four byte variables out1, out2, out3, and out4 together and writes them to LEDs zero through four. In your main program, write some code that reads the switches, computes the following boolean functions, stores the function results in out1..out4, and then outputs these values to the LEDs.

Boolean Functions to support:

```

out1 = sw1•sw2 + sw3•sw4
out2 = sw1•sw2'•sw3•sw4' + sw1•sw2•sw3
out3 = sw1'•sw2'•sw3'•sw4' + sw1•sw2•sw3•sw4 + sw1'•sw2•sw3•sw4' + sw1•sw2'•sw3'•sw4
out4 = sw1 + sw2 + sw3'•sw4'

```

You can use the proj7\_5.asm file as a “shell” for this project.

- Program #8: The file “proj8\_5.asm” on the diskette accompanying this lab manual is a short program that creates a “light show” on the circuit you constructed in the Chapter Two laboratory. Modify this file to produce a light show of your own. Some suggestions: by calling the delay routine several times in a row you can lengthen the time that one pattern appears on your LEDs. If you adjust the logic of the program a little, you can use different delays between different patterns to improve your light show.

---

## 6.21 Solutions to Selected Exercises

1) One possible example (there are many)  $FF+FF=1FE$ .  $FF$  is the largest possible eight bit value. The sum of these two large values requires only nine bits to hold the result.

4) Possible ways:

```

add    bx, 2
inc    bx
inc    bx
lea    bx, 2[bx]
sub    bx, -2
clc
adc    bx, 2
stc
adc    bx, 1
lea    bx, 1[bx]
inc    bx
inc    bx
add    bx, 1
etc.

```

5a) 

```
jns    TempL1
      jmp    Label1
```

TempL1:

15) The sign never changes with SAR, so arithmetic overflow does not occur.

17) IMUL is necessary for operations like array subscript computations. IDIV isn't used as often as IMUL.

21a) Zero.

21d) Carry and zero.

22c) Sign and overflow.

22d) Sign, overflow, and zero.

24) One way to do it (most ways involve using several registers):

```

mov    ax, I
mov    bx, J
mov    I, bx
mov    J, ax

```

25) One way to do it:

```

mov    ax, I
xchg  ax, J
mov    I, ax

```

30) Copying the floating point status register bits into the 80x86 flags register.

34) Point BX at a table whose entries are equal to their index into the table except for indices 'a'..'z'. In these entries put the upper case characters.

46) 

```
pop    mem32
jmp    mem32
```





